

VICTORIAN RECREATIONAL BOATING SAFETY HANDBOOK



MAY 2021
transportsafety.vic.gov.au/msv



A branch
of Transport
Safety
Victoria



EMERGENCY PROCEDURES

ALL OCCUPANTS TO PUT ON LIFEJACKETS



RAISING THE ALARM - HOW TO GET HELP



BY PHONE:
Call 000



BY FLARES:
Activate when you see a potential rescuer or when you believe they will be seen



BY MARINE RADIO:
VHF - Ch 16,
VHF - Distress button
on DSC equipped and
registered radios

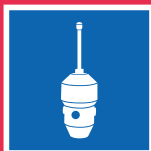

BY EPIRB/PLB:
Activate your distress beacon:
a PLB or registered EPIRB

STAY WITH YOUR BOAT



- A vessel is a lot easier to spot than a person
- Anchor your vessel to maintain position if it is safe to do so.



Only digital 406MHz EPIRBs are detected by satellite. Analogue 121.5MHz EPIRBs are not detected. Switch to a digital 406MHz EPIRB and register it with the Australian Maritime Safety Authority.



GET PREPARED GET BOATING VIC

- » Over 400 ramps & launching spots in Victoria
- » Real-time ramp images, photos & more
- » Localised hourly weather like never before
- » Waterway & facility information
- » Expert advice & resources in one place

Trip preparation at your fingertips.

Download the Boating Vic app or visit boating.vic.gov.au

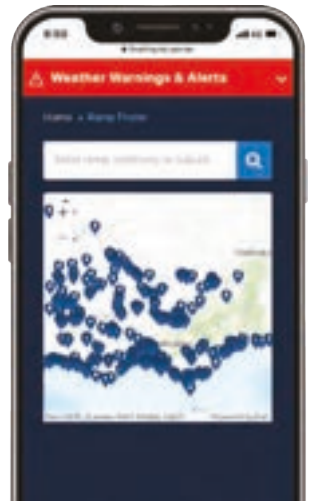

TRIP PREPARATION



Properly maintain your vessel, engine and safety equipment



Check the marine weather report



Ensure you have sufficient fuel and reserve fuel



Fully charge your batteries



Inform a person of your trip intentions



A marine licence is required to be the master of a recreational power boat in Victoria

SAFE OPERATION

On ALL Victorian waters a 5 knot speed limit applies to boat operators and PWC operators within a distance of:



50 m of a person, vessel, fixed or floating structure and the shore on inland waters



50 m of a person, vessel, wharf, jetty, slipway, diving platform or boat ramp on coastal and enclosed waters



100 m of a dive flag



200 m of the shore on enclosed and coastal waters



or as per the scheduled waterway rules



CONTENTS

REGULATORY ENVIRONMENT

Introduction	3
Safety duties	5

CHAPTER 1 ESSENTIALS FOR SAFE BOATING

Before you go boating	23
Heightened risk	34
Safety equipment	35
Lifejacket wear	45
Trip preparation	50
Weather hazards and conditions	52
Crossing ocean bars	56
Interstate boating	57
Environment and wildlife	59
Marine national parks and marine sanctuaries	61
Environment protection	62

CHAPTER 2 SAFE OPERATION

Speed and distance rules	67
Hoon laws	68
Alcohol and drugs	68
Transit only zones and channels	69
Know the Collision Regulations	70
Buoyage IALA System A	77
Buoyage types	79
Boating zone buoyage (inland waterways)	85
Boating zone marks and signage	86
Navigation lights	86
Day shapes for vessels	95
Sound and light signals	98
Basic boat handling tips	100
Towed water sports	105

CHAPTER 3 EMERGENCY PROCEDURES

Coping with emergencies	112
Abandoning vessel	117
Person overboard	117
Cold water immersion	118
Fire	120
Carbon monoxide poisoning	121
First aid	122
Reporting incidents and accidents	122

CHAPTER 4 LICENSING AND REGISTRATION

Recreational marine licensing	125
Types of marine licences	126
Operating under supervision	127
Hire and drive requirements	127
Obtaining a marine licence	128
Marine licence fees	129
Interstate marine licence holders	129
Victorians travelling interstate	130
People visiting Victoria	130
Commercial marine qualifications holders	130
Evidence of identity	130
Applicants with poor vision	131
Applicants with a disability or medical condition	131
Vessel registration requirements	131
Registration labels and identification marks	132
Hull identification number	132

CHAPTER 5 PERSONAL WATERCRAFT (PWC)

Personal watercraft	135
PWC operator conduct	135
Speed and distance rules	136
Know the Collision Regulations	138
Hoon laws	138
Noise	138
Safety equipment	139
Towed water sports	139
Carrying capacity	139
Penalties	139
Licensing and registration	140
Ride Right	141



REGULATORY ENVIRONMENT

INTRODUCTION

About Maritime Safety Victoria
Acts and Regulations

3
4
4

SAFETY DUTIES

The master of a vessel
Duties to take reasonable care
Reasonable care in practice
Owner onus
Waterway managers
Waterway rules – Vessel Operating and Zoning Rules (VOZR)
Waterways
Notice to Mariners
Harbour Master's Directions
Australian Builders Plate (ABP)
Vessel safety
Fit for purpose

5
5
5
6
6
6
7
15
15
16
17



INTRODUCTION

Maritime Safety Victoria (MSV) is committed to safe vessel operations and safe waterways for all Victorians.

Boating is great fun but has inherent dangers, and we want all boaters to be prepared to come home safely.

Maritime Safety Victoria has developed this Safety Handbook to provide advice and help you understand and apply the various acts and regulations which bind Masters - those who have command or charge of boating vessels - who operate on Victorian waterways.

Please note: Reading this Safety Handbook does not replace the need to understand and consult the relevant marine safety laws for the state (see Acts and Regulations).

This Safety Handbook should be used to prepare for achieving the Victorian Marine Licence and Personal Watercraft Endorsement tests.

It is also a useful reference document to have at home or on board.

Happy and safe boating.



ABOUT MARITIME SAFETY VICTORIA

Maritime Safety Victoria is a branch of Transport Safety Victoria, the state's independent transport safety regulator.

The Director, Transport Safety (referred to in this Safety Handbook as the Safety Director) advises and makes recommendations to the Minister for Ports on boating safety matters.

MSV aims to improve safety outcomes by regulating recreational vessel operations and ensuring a safe environment for their navigation on Victorian waters.

MSV regulates through:

- issuing vessel registrations and marine licences
- information and education activities
- enforcement activities.

Information and education activities include such things as providing information, guidance and education, conducting safety inspections and reviewing safety assessment or management documentation.

Enforcement activities include such things as prohibiting unsafe activities and vessels, issuing infringement and improvement notices, conducting inquiries, taking disciplinary action and prosecuting for serious breaches of marine safety law.

These activities are supported by the positive working relationships MSV enjoys with maritime industry stakeholders, including port and waterway managers.

Any reference to MSV in this publication is also a reference to TSV.

ACTS AND REGULATIONS

All recreational boaters and their vessels are required to comply with the relevant marine safety laws in the State. This includes (but is not limited to):

- *Marine Safety Act 2010* (Vic)* (MSA)
- *Marine Safety Regulations 2012* (Vic)* (MSR)
- Vessel Operating and Zoning Rules (VOZR) for Victorian Waters*
- International Regulations for Preventing Collisions at Sea 1972 (COLREGS)
- relevant rules made by port managers or waterway managers
- relevant Harbour Master Directions.

Copies of Victorian legislation and Parliamentary documents are available at legislation.vic.gov.au

*The Marine Safety Act, Marine Safety Regulations and Vessel Operating and Zoning Rules, and more general information on marine safety requirements, are available online at transportsafety.vic.gov.au/msv

SAFETY DUTIES

THE MASTER OF A VESSEL

The MSA defines the master of a vessel as someone who has command or charge of the vessel.

A master is therefore distinguished from:

- an owner, being someone who owns the vessel
- an operator, being someone who controls the movement of the vessel.

For example, you as the owner of a vessel may allow your friend to be in charge of the vessel while it is out on the water.

Your friend is now the master. If this friend decides not to operate the vessel himself but instructs another person to operate it, they become the operator.

The master must hold a Marine Licence (see Chapter 4) and comply with various requirements on masters under marine safety law. The requirements include those in relation to operating the vessel, reporting incidents or following notices from, or directions of, Victoria Police, TSV transport safety officers and other external officers appointed by the Safety Director. It is therefore important for everyone to know who is the master of any vessel before going on the water. If this is not clearly articulated, then the owner may be assumed to be responsible for certain offences relating to the operation of the vessel (see Owner Onus section).

DUTIES TO TAKE REASONABLE CARE

All persons participating in the operation of a recreational hire-and-drive vessel (as a master, operator, crew, or passenger), or those being towed, are responsible for their individual and collective safety, and the safety of those in the vicinity of the vessel. The MSA imposes a specific legal duty on all those participating in the operation of recreational or hire and drive vessels, together with their passengers, to take 'reasonable care' to protect themselves and others from harm, including to not intentionally or recklessly expose others to unnecessary risks.

REASONABLE CARE IN PRACTICE

In general, having good safety practices (including complying with this Safety Handbook, waterway rules and all other relevant safety standards) goes a long way to demonstrating you have taken 'reasonable care'.

In addition, masters are expected to ensure that:

- the safety equipment on board is in good working order
- the condition of the vessel is well-maintained and safe (hull, deck, engine conditions, fuel systems, electrical systems etc.)
- you have prepared adequately for your trip (waterway zoning and maps, weather/wind/wave conditions, safe loading etc.)
- you navigate the vessel safely (steering and sailing rules, anchoring, launching, retrieving, crossing ocean bars etc.)
- all persons on board understand and comply with required emergency procedures
- they proceed to and assist people in distress in a safe manner.

OWNER ONUS

The MSA introduced an owner onus system for certain offences. The system is based on the principle that, if the identity of the master or person in charge is not established at the time the offence is detected, the owner is generally liable for the offence unless they can show that they were not responsible for the vessel at the time of the offence and provide information sufficient to identify and locate who was.

WATERWAY MANAGERS

Waterway managers are agencies which have been appointed by the Minister for Ports, to manage safety on particular waterways. The Department of Environment, Land, Water and Planning (DELWP), Parks Victoria, Gippsland Ports and Goulburn Murray Water (GMW) are the largest waterway managers.

Maritime Safety Victoria assists ports and waterway managers to ensure safety on Victorian waters.

The role of waterway managers is to:

- manage vessel activities on waters under their control
- allocate and manage moorings and berths
- provide and maintain navigation aids, appropriate signage of water levels, hazards, and rules applying to the waters
- control navigation and vessel movement
- designate areas in which anchorage of vessels is, or is not, permitted
- alter or dredge channels for navigation
- remove or mark obstructions.

You can find a full list of waterway managers at transportsafety.vic.gov.au/msv/waterways

WATERWAY RULES – VESSEL OPERATING AND ZONING RULES (VOZR)

All masters must familiarise themselves with Waterway Rules as described in the Guide to Vessel Operating and Zoning Rules (VOZR). The VOZR details the state and local waterway rules in place for all Victorian waterways.

Waterway rules identify:

- speed limits and safety distances
- vessel prohibited zones
- exclusive use and special purpose areas
- prohibition of specific activities.

Waterway rules are designed to provide a safe operating environment by:

- catering for a wide range of boating and water activities
- separating different activities, where needed, on the basis of safety
- reflecting local conditions.

From time to time, these rules are amended because of changing local conditions and boating activity or works.



Boaters should consult the VOZR to become aware of waterway rules

WATERWAYS

Waterway types

Waterways are described as one of three types:

- Coastal
- Enclosed
- Inland

Conditions vary significantly between waterway types, and where they meet.

It's an important duty of Masters to be aware of waterway types in which you're operating, in order to know which is the appropriate safety equipment to carry on your vessel (see the Safety Equipment and Lifejacket wear sections).

Victorian Waterways

This section outlines the waterway types for each Victorian waterway in maps which include condition warnings for dangerous areas.

Where waterways cross the border between Victoria and New South Wales, for the purposes of transport safety legislation, Victorian rules apply in the sections described below:

- Ovens River south of the Murray Valley Highway Bridge
- Lake Hume downstream of the Bethanga Bridge
- Those waters contained within the Victorian border of the lower Glenelg River.

NSW Waterways

Waters of the Murray River, Lake Mulwala and Lake Hume not listed above are within New South Wales jurisdiction. Operators are advised that NSW legislation applies on these waters. Contact NSW Roads & Maritime Services on (02) 9563 8557 or visit maritime.nsw.gov.au

Refer to page 57 for more information on boating in NSW.





The specific waterway rules for each Victorian waterway are set out in the Vessel Operating and Zoning Rules (VOZR). An up-to-date copy of the rules can be accessed on the TSV website transportsafety.vic.gov.au/msv/waterways



COASTAL WATERS



ENCLOSED WATERS



INLAND WATERS

BASS STRAIT (PORT PHILLIP AND WESTERNPORT)



Designated Hazardous Area - Port Phillip Heads

Port Phillip Heads means all the waters between an imaginary line drawn between Shortland Bluff and Point Nepean, and the seaward limits of an imaginary line consisting the arc of a circle with a radius of three nautical miles centred on Point Lonsdale (as indicated in red above). This definition of Port Phillip Heads now includes the area at the entrance to Port Phillip Bay where conditions are known to present additional risks to vessels operating there.

Port Phillip Heads and any area of State waters declared by the Safety Director is classified as a Designated Hazardous Area.

transportsafety.vic.gov.au/msv/heads

PORT OF PORTLAND

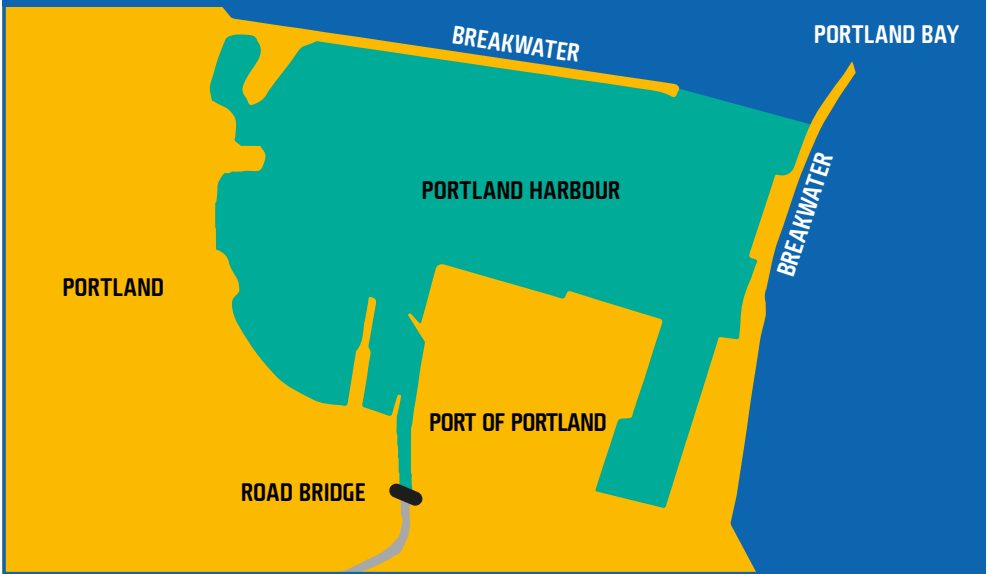

PORT OF PORT FAIRY

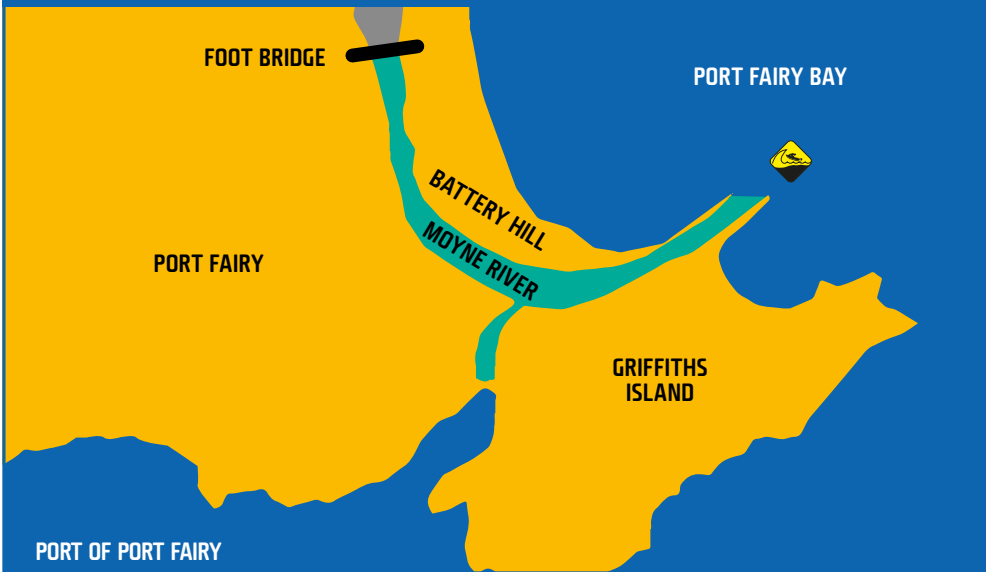

- Strong tides, currents and dangerous waves may exist where enclosed waters meet coastal waters
- Enclosed waters sealed off from coastal waters may break out causing extremely dangerous conditions

WARRNAMBOOL



BARWON HEADS

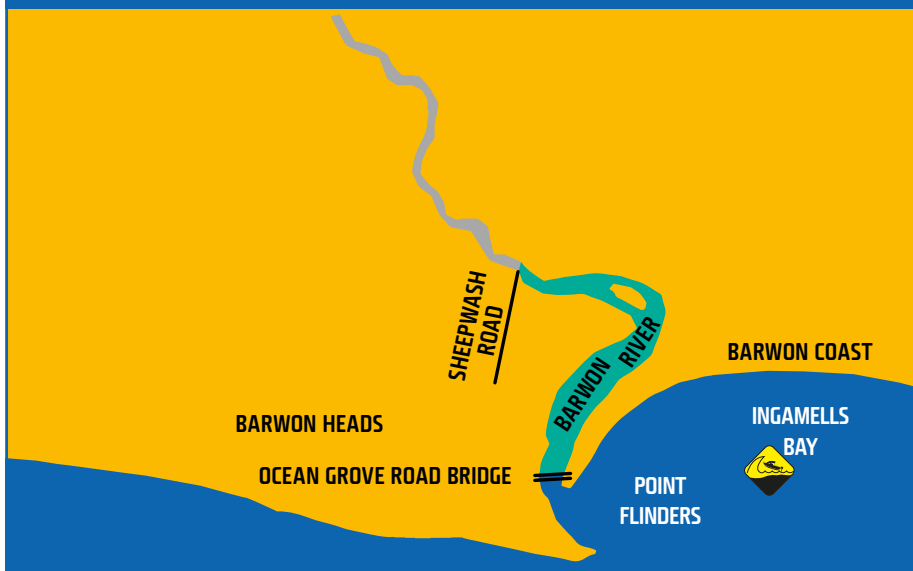

INLAND WATERS Inland waters, apart from those depicted in grey above, are defined as rivers, creeks, canals, lakes and reservoirs which are either naturally formed or man-made. They may be publicly or privately owned, but do not include navigable rivers, creeks and streams within declared port waters.

MELBOURNE AND PORT PHILLIP



ANDERSON INLET

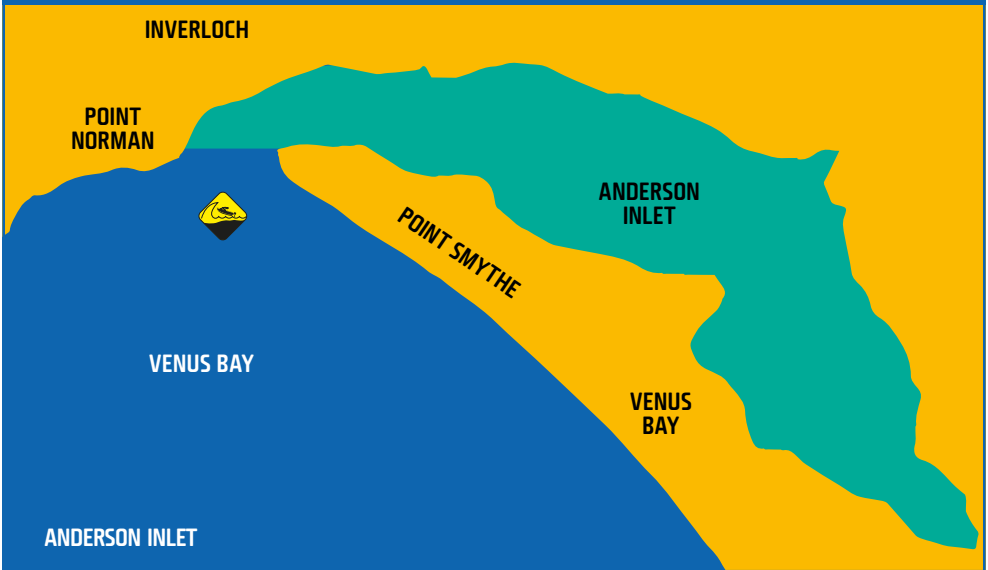

- Strong tides, currents and dangerous waves may exist where enclosed waters meet coastal waters
- Enclosed waters sealed off from coastal waters may break out causing extremely dangerous conditions

SHALLOW INLET



CORNER INLET AND PORT ALBERT

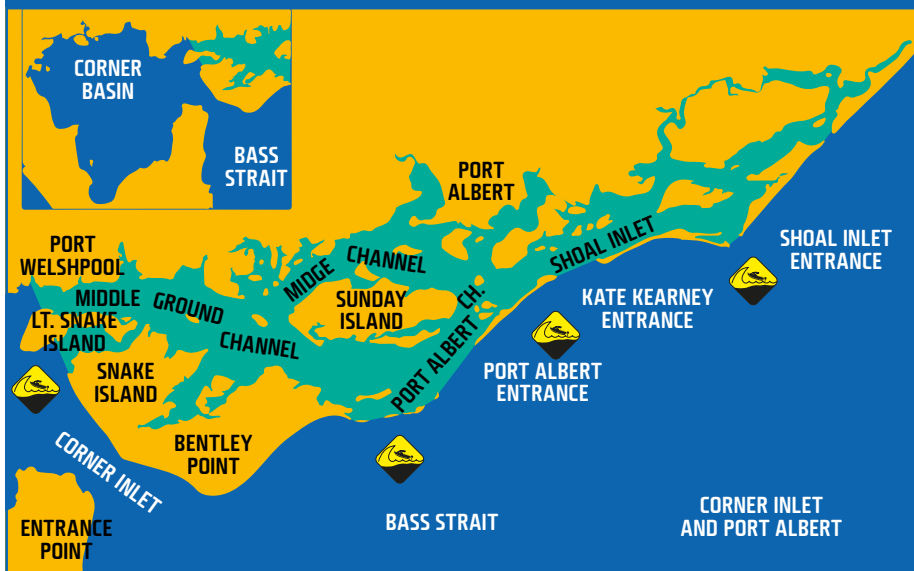

INLAND WATERS Inland waters, apart from those depicted in grey above, are defined as rivers, creeks, canals, lakes and reservoirs which are either naturally formed or man-made. They may be publicly or privately owned, but do not include navigable rivers, creeks and streams within declared port waters.

LAKES ENTRANCE



SNOWY RIVER

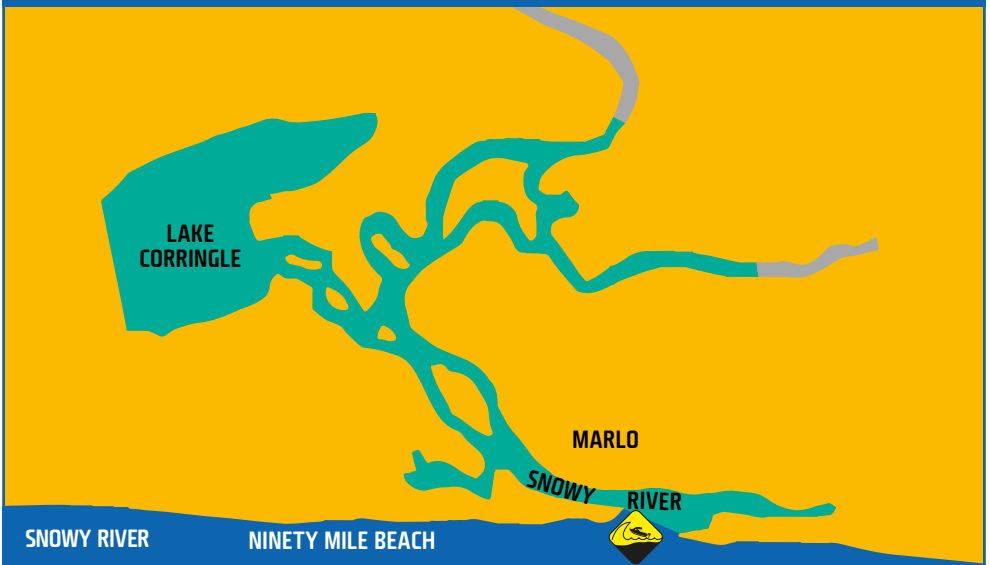

- Strong tides, currents and dangerous waves may exist where enclosed waters meet coastal waters
- Enclosed waters sealed off from coastal waters may break out causing extremely dangerous conditions

SYDENHAM INLET & TAMBOON INLET



WINGAN INLET



MALLACOOTA



INLAND WATERS Inland waters, apart from those depicted in grey above, are defined as rivers, creeks, canals, lakes and reservoirs which are either naturally formed or man-made. They may be publicly or privately owned, but do not include navigable rivers, creeks and streams within declared port waters.

NOTICE TO MARINERS

Maritime Safety Victoria and other relevant agencies provide critical timely advice and updates on safety issues, as a 'Notice to Mariners'.

For up-to-date notices, visit transportsafety.vic.gov.au/msv/notices

HARBOUR MASTER'S DIRECTIONS

Harbour Masters are responsible for the safe operation and passage of all vessels, including recreational, within the ports required to have a Harbour Master in place.

These ports, as declared by Maritime Safety Victoria, are:

- Hastings
- Geelong
- Melbourne
- Gippsland
- Portland

All Masters must comply with the directions given by the Harbour Master.

For further information: transportsafety.vic.gov.au/msv/hmd

AUSTRALIAN BUILDERS PLATE (ABP)

An Australian Builders Plate (ABP) gives key safety information at a glance whether you are buying a boat or going out boating. The ABP aims to make boating safer by providing information about the carrying capacity of vessels including the maximum number of people and load they can safely carry, the maximum outboard engine power and the buoyancy performance for smaller vessels.

The MSA requires that all vessels of a prescribed class, that are supplied after 1 July 2012, must comply with the National Standard for the ABP for recreational boats. The ABP Standard, as modified by the MSR in Victoria, requires that an ABP must be fixed to most recreational vessels (excluding, for example, second-hand, paddle-powered or sailing boats).

ABPs for vessels less than six metres need to display a buoyancy statement and specify either basic or level flotation. ABPs for vessels more than 6 m do not require a buoyancy statement.

For more information on ABPs, visit transportsafety.vic.gov.au/msv/abp



VESSEL SAFETY

The MSR require that the owner or master of a vessel must not allow the vessel to be operated if it is not fit for purpose or in a way that is in breach of any condition of the relevant vessel registration or marine licence.

A vessel is unsafe if the operation of it may endanger any person because of the:

- condition or equipment of the vessel
- manner in which cargo and equipment is stowed or secured
- nature of the cargo
- overloading of the vessel with persons or cargo
- number or qualifications of the vessel's crew
- the absence of marine safety equipment that is required to be carried or installed on the vessel.

Knowing the capabilities and limitations of your vessel, keeping it clean, tidy, well maintained and well supplied will go a long way to keeping you and those around you safe on the water.

If your vessel is not fit for purpose or is unsafe, MSV may order the vessel to be provisionally or permanently detained. Police officers, TSV transport safety officers and other external officers appointed by the Safety Director may also direct that the vessel not be operated on Victorian waters or only under certain conditions.

You should consider the waterway and conditions before you head out and ensure that your vessel is appropriate for that environment.

Seek advice from the manufacturers on maximum loads and types of activities your vessel is designed to encounter.



FIT FOR PURPOSE

The MSR defines a vessel fit for purpose if:

- a. the hull of the vessel is able to maintain watertight integrity
- b. there is no fuel leaking from the vessel's fuel system or engine
- c. the vessel's steering system controls the movement of the vessel
- d. the ventilation system used for ventilating a space or spaces in the vessel is functioning
- e. the material insulating machinery in the vessel from fire or flammable materials is fitted and undamaged
- f. the materials or items comprising part of the vessel's reserve buoyancy are fitted and undamaged
- g. the engine kill switches are fitted to the vessel and are operable.

KEEP YOUR VESSEL FIT FOR PURPOSE

PROPERLY MAINTAIN YOUR VESSEL



- Inspect propeller nut and pin
- Check for water and fuel leaks
- Ensure bung is suitable and in good condition
- Ensure bilges are clean and dry
- Check reserve buoyancy for condition
- Test steering for stiffness
- Check wiring
- Check and clean fuel filter
- Clean cooling system passages
- Replace outboard pull cord if fraying.

FULLY CHARGE YOUR BATTERIES



- Top up battery cells with distilled water and check each cell with a hydrometer
- The battery should be charged but never overcharged
- The terminals, cables and casings should be kept clean
- Test all electrical equipment operating from the battery such as radios, gauges, power tilt, navigation lights.

ENSURE YOU HAVE SUFFICIENT FUEL



- Allow 1/3 out, 1/3 return and 1/3 reserve
- Always replace old fuel after periods of inactivity
- Inspect fuel lines, manual priming bulb and connections for cracks, leaks, etc.
- Inspect the fuel tank for cracks or corrosion
- Always check for fuel smells and ventilate your vessel well before starting the engine.

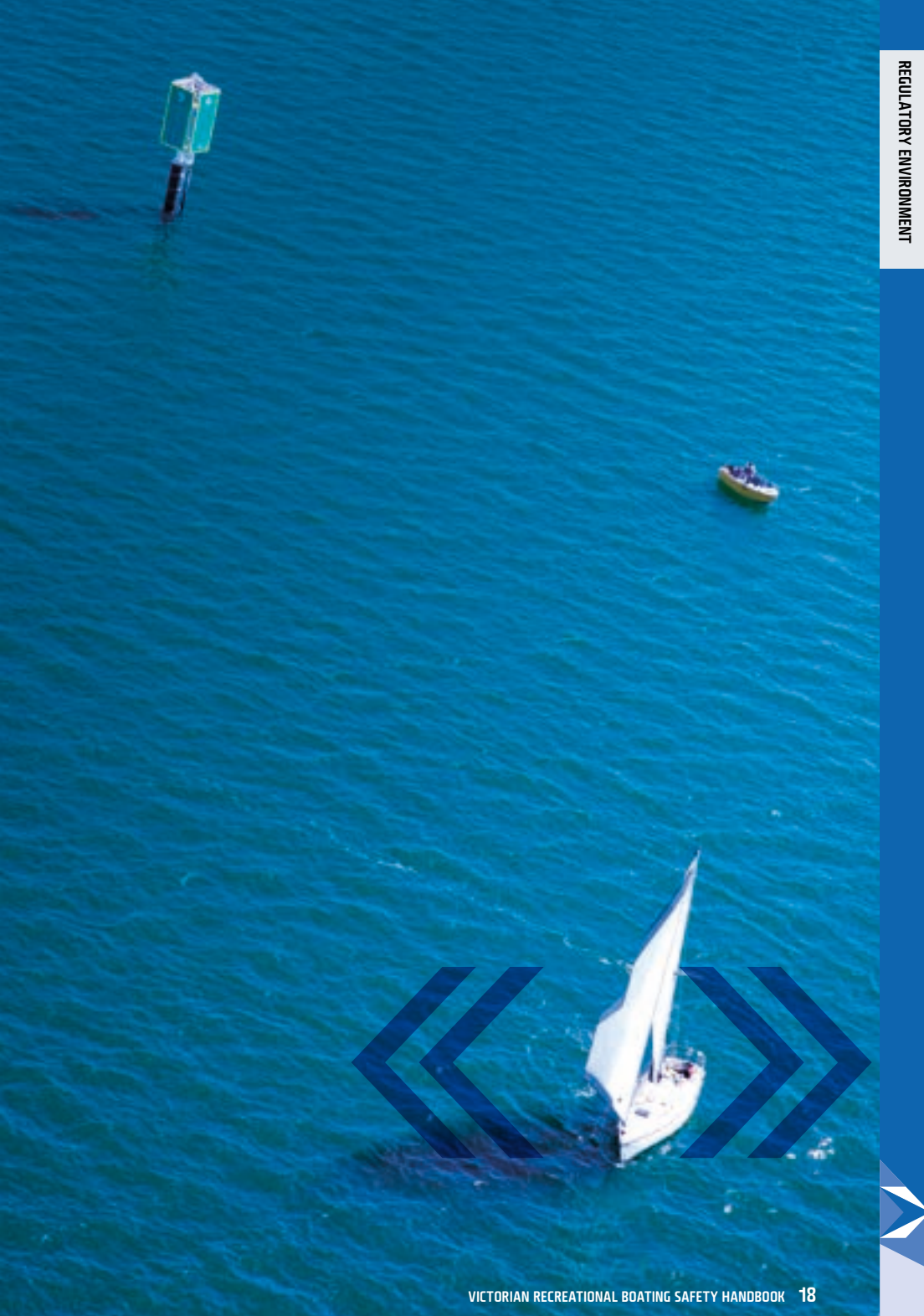

CHAPTER 1

ESSENTIALS FOR SAFE BOATING





BEFORE YOU GO BOATING	23
Maintaining your vessel	23
Raising the alarm (calling for help)	25
Safe loading	29
Vessel stability	31
Flotation	32
Boating with children	33
HEIGHTENED RISK	34
SAFETY EQUIPMENT	35
Safety equipment exemptions	35
Safety equipment maintenance and placement	35
Length of vessel	36
Safety equipment carriage checklist:	37
- Powerboat	37
- PWC	37
- Yacht	38
- Off-the-beach sailing yacht	39
- Stand up paddleboard	39
- Human powered vessels (including kayak, canoe, raft and rowing boat)	40
- Funboat and pedalboat	40
Safety equipment features and standards	41
LIFEJACKET WEAR	45
When in an open area of a vessel that is underway	45
During times of heightened risk	45
Lifejacket types	46
Lifejackets on children	48
Lifejackets on babies and toddlers	48
Lifejacket maintenance	49
TRIP PREPARATION	50
Pre-trip check list	50
Let someone know before you go	50
Study the weather	51
WEATHER HAZARDS AND CONDITIONS	52
Be prepared	52
Know what the forecast is telling you	53
Waves	53
Thunderstorms	54
Offshore winds	55
Local knowledge	55
Navigational charts	55
CROSSING OCEAN BARS	56
Exercise extreme caution	56
Be aware	56
Preparing to cross a bar	56
Crossing a bar	56
Interstate boating	57

ENVIRONMENT AND WILDLIFE

- Whales, dolphins and seals
- Recreational fishing regulations
- Aquaculture fisheries reserves

59
59
59
59

MARINE NATIONAL PARKS AND MARINE SANCTUARIES

- Restrictions
- Boundary markers
- Publications and further information

61
61
62

ENVIRONMENT PROTECTION

62



BEFORE YOU GO BOATING

Before you go boating be prepared for as many possibilities as you can. Have a vessel which is fit for the purpose for which it will be used. Carrying safety equipment relevant to the waterway, and being able to raise the alarm will also dramatically reduce the chance of a small incident having a catastrophic result.

MAINTAINING YOUR VESSEL

Keeping your vessel in good working order or 'winterising' it, is a key to enjoying your activity. The table provides information about type of maintenance required for each vessel part. Maintenance periods are broken down into pre-season, mid-season and post-season.

TIPS FOR REFUELLING SAFELY

- No passengers are permitted on board during refuelling or restarting.
- Turn off the engine and electrical equipment before refuelling.
- Don't overfill your fuel tank and clean up spills immediately.
- Ventilate the tank and engine compartments after refuelling.
- Don't start the engine if you can detect fumes.
- If possible, fill the fuel tanks away from the vessel in a well-ventilated, no smoking area.
- When refuelling, use a wide-mouthed funnel and clean up any splashes immediately.
- Regularly check perishable fuel lines for wear and tear and carry spares.
- Don't keep oily or fuel-soaked rags onboard.
- Keep spare fuel in a tightly capped, secure container.

VESSEL PART

Fuel tank

Fuel line

Fuel filter

Fuel system (if you suspect any ethanol fuel blend has been used)

Batteries

Wiring

Spark plugs

Steering gear and other moving parts

Cooling system

Propeller

Reserve buoyancy

Hull and outer surfaces

PRE-SEASON	MID-SEASON	POST-SEASON
<ul style="list-style-type: none"> • Avoid using old fuel Keep clean and dry 	<ul style="list-style-type: none"> • Check for water in fuel 	<ul style="list-style-type: none"> • Store in dry place (vented) • If metal, swish with 2 stroke oil
<ul style="list-style-type: none"> • Check for cracking and loose fittings 	<ul style="list-style-type: none"> • Watch for leaks 	<ul style="list-style-type: none"> • Drain
<ul style="list-style-type: none"> • Check and replace as necessary 	<ul style="list-style-type: none"> • Check and clean 	<ul style="list-style-type: none"> • Check and clean
<ul style="list-style-type: none"> • Drain and clean out tank • Clean fuel lines • Change fuel filters • Have engine fuel system checked and serviced 	<ul style="list-style-type: none"> • Do not leave ethanol fuel standing in any tanks • Check fuel filters • Monitor engine operating temperature 	<ul style="list-style-type: none"> • Drain all ethanol blended fuel from tanks, fuel lines and carburettors
<ul style="list-style-type: none"> • Check electrolyte, top up with distilled water • Recharge, check mountings, clean terminals 	<ul style="list-style-type: none"> • Check electrolyte top up with distilled water • Recharge, check mountings, clean terminals 	<ul style="list-style-type: none"> • Check electrolyte, top up with distilled water
<ul style="list-style-type: none"> • Check for cracking, loose wire and corrosion 		
<ul style="list-style-type: none"> • Clean and check the gap or replace 	<ul style="list-style-type: none"> • Watch for fouling, moisture • Keep engine tuned • Clean and check the gap as necessary 	
<ul style="list-style-type: none"> • Lubricate all moving parts 	<ul style="list-style-type: none"> • Lubricate every 60 days 	<ul style="list-style-type: none"> • Lubricate before storing
<ul style="list-style-type: none"> • Clean passages 	<ul style="list-style-type: none"> • Check ports for weeds • Flush after use in salt water 	<ul style="list-style-type: none"> • Flush with water • Drain all water by pull starting with plugs disconnected
<ul style="list-style-type: none"> • Sand or file small nicks 	<ul style="list-style-type: none"> • Check regularly 	<ul style="list-style-type: none"> • Check condition • Repair if required
<ul style="list-style-type: none"> • Check condition and that it is securely in place, replace worn or degraded materials 	<ul style="list-style-type: none"> • Regularly check it is securely in place 	<ul style="list-style-type: none"> • Keep clean and dry
<ul style="list-style-type: none"> • Clean hull • Replace sacrificial anodes as appropriate 	<ul style="list-style-type: none"> • Keep clean 	<ul style="list-style-type: none"> • Keep clean, touch up with paint (but don't paint the anodes)

RAISING THE ALARM (CALLING FOR HELP)

There are various ways of calling for help and it is important to be familiar with the features and what is involved in using all the options.

Emergency position indicating radio beacon (EPIRB)

The MSA requires that all recreational vessels venturing more than two nautical miles (nm) from the coast carry a registered, current EPIRB. Although EPIRBs are only required when venturing more than 2 nm from the coast, EPIRBs can be useful for raising the alarm on any waterway.

An EPIRB is waterproof, will float upright for best signal transmission and has a lanyard to attach it to yourself or a floating object. It is also advisable to purchase a model of EPIRB which features a strobe light and GPS enhancement to provide searchers with a smaller search area.

Once activated, an EPIRB transmits a distress signal for at least 48 hours that can be detected by satellite and overflying aircraft. EPIRB alerts detected off Victoria are received by Australian Maritime Safety Authority (AMSA) in Canberra and relayed to the local rescue co-ordination centre.

The EPIRB should be accessible but stowed in a way to avoid accidental activation.

Check the battery and registration expiry date on your EPIRB before taking out your vessel. When testing an EPIRB, strictly follow the manufacturer's instructions.

Compulsory registration of your EPIRB is free. Visit beacons.amsa.gov.au or call 1800 406 406. Registration details must be updated when any of your registered details change, or every two years. Analogue 121.5MHz beacons are no longer acceptable for use in the maritime environment.

Personal locator beacon (PLB)

A PLB is smaller and more convenient to carry than an EPIRB. A PLB may not float in an orientation that provides good signal transmission. It may not have a lanyard and is required to operate for only 24 hours. A PLB is not an EPIRB and does not meet the legislative requirements for the carriage of EPIRBs. However, MSV recommends that a PLB is worn by all boaters who are boating alone.

Beacon disposal

Please do not throw unwanted beacons in the bin - they can inadvertently activate if incorrectly disposed of in the rubbish.

To dispose of unwanted distress beacons (EPIRBs and PLBs):

Option 1. Contact your local battery store to check whether they can disconnect and dispose of beacons. A small fee may apply.

Option 2. Check the beacon manufacturer's instructions. They may provide instructions on how to disconnect the beacon battery and how to correctly dispose of the beacon and battery.

After disposing of your unwanted beacon please advise AMSA by updating your online registration account at beacons.amsa.gov.au or phoning 1800 406 406.

Marine radio

A marine radio is:

- A radio operating on VHF marine radio channels
- A radio operating on MF/HF marine radio frequencies
- A radio operating on 27MHz marine radio channels

Marine radios provide a means of:

- calling for assistance if a vessel is in distress
- monitoring and/or updating rescue operations
- positioning a vessel by radio direction finding
- receiving weather forecasts
- communications between vessels

Marine Radio Victoria replaces Coast Radio Melbourne and provides a marine distress and emergency monitoring system for Victorian Coastal waters. Marine Radio Victoria uses a new **VHF** coastal network completed in 2017.

Radio calls are monitored and recorded 24/7 along the entire Victorian coastline to 20 nm from the coast. Operators are also able to check weather conditions and conduct radio checks through Marine Radio Victoria.

Some Marine Search and Rescue agencies provide track following services along the coast on VHF channels.

MF/HF radio for longer range communications is based in Charleville. Charleville Radio (VMC) monitors HF distress channels 24/7 and provides weather information services.

Marine radio channels

DISTRESS CHANNELS/FREQUENCIES

Radio	Channel/Frequencies
VHF	16 (67 alternative)
HF (frequency)	4125,6215 and 8291 kHz

27 MHz radio is no longer recommended for marine use. Its broadcasting and reception is not as reliable as VHF and it is not consistently monitored along the Victorian coastline.

For emergency radio use and messages see chapter 3 about emergency procedures.

VHF Radio

A marine radio is required on most vessels when venturing further than 2 nm from the coast.

Refer to safety equipment tables on pages 37-40 to understand when a marine radio is required.

The Marine Radio Operator's Handbook, available through the Australian Maritime College at amc.edu.au/industry/omc, provides information on correct operating procedures, maintenance of equipment and how to deal with minor faults at sea. The person operating the marine transceiver must hold an appropriate qualification.

Marine radio operator certification

An operator's certificate is required to transmit using VHF and HF radio.

Qualifications and The Marine Radio Operator's Handbook are available through the Australian Maritime College at amc.edu.au/industry/omc.

MF/HF radio sets require an apparatus licence administered by ACMA.

For further information about marine radio requirements, including any changing requirements, please visit the Australian Communications and Media Authority (ACMA) website: acma.gov.au

VHF MARINE RADIO CHANNELS



Flares

All registered vessels are required to carry two hand-held red distress flares and two hand-held orange smoke signal flares, of an approved type, when operating on coastal and enclosed waters. Additionally, when operating more than 2 nm offshore in coastal waters, a mechanically or sailed powered vessel must carry one red star parachute rocket flare.

Orange smoke signals, which can be seen for up to 4 km (10 km by aircraft) should be used in daylight to pinpoint your position.

Red distress flares, which have a visibility range of 10 km, are designed for use at night but can also be seen during the day.

A red star parachute distress rocket is designed to fire a single red star to a height of approximately 300 m. The star burns while falling for at least 40 seconds and can be seen from the greatest distance due to its intensity and elevation from sea level.

Using and maintaining flares

Always delay using flares until you can see an aircraft, or until people on shore or in other boats are in visual range.

- Keep flares away from fuel and combustibles.
- Ensure flares are stored in an accessible but dry place, as they attract moisture.
- Be prepared – ensure everyone on board your vessel knows where the flares are stored and how to use them.
- Ensure that you carefully follow the activation instructions of all flares.

Expired flares

Approved smoke signals, distress flares and parachutes have expiry dates clearly marked. Expired flares should not be carried on your vessel. Flares can become dangerous and unpredictable as they age. Their life span is usually three years and you must ensure they are replaced when the expiry date is reached.

Boat owners should dispose of their expired flares at selected police stations. Contact your local police station for specific locations.

SAFE LOADING

The MSR requires that a person must not act as the master of a recreational vessel or a hire and drive vessel that is overloaded. Overloading is dangerous and seriously reduces the stability and seaworthiness of your vessel.

A recreational vessel is overloaded if the number of persons on board the vessel exceeds the maximum number of persons specified by the manufacturer of the vessel on a capacity plate or an Australian Builder's Plate (ABP). Or the number specified against the vessel length in the table below.

Vessels with a fly bridge are prone to capsizing if the fly bridge is overloaded.

Unless specified by the manufacturer, the maximum number of people which can be carried in a recreational vessel is represented in the table below.

LENGTH OF VESSEL	MAXIMUM PASSENGERS*
Less than 3 m	Two people
3 m to less than 3.5 m	Three people
3.5 m to less than 4.5 m	Four people
4.5 m to less than 5 m	Five people
5 m to less than 5.5 m	Six people
5.5 m to less than 6 m	Seven people

Note:

- a child up to and including one year of age does not count for the purpose of calculating maximum passengers
- each child over one year and under 12 years equals half an adult
- on recreational vessels with individual cockpits (for example, decked canoes or kayaks), the number of persons carried on the vessel must not exceed the number of individual cockpits, irrespective of the age of the person.

*WARNING: This is the maximum carrying capacity for good conditions. A reduction in the maximum number of persons must be made in adverse conditions or when on the open sea. Capacity of a person is assessed at 75 kg per person with an additional allowance of 15 kg per person for personal gear. A reduction in the number of persons must be made when equipment and supplies exceed total weight allocated.



VESSEL STABILITY

Overloading your boat seriously reduces stability and free board making your boat less able to resist waves and more likely to be swamped and capsized.

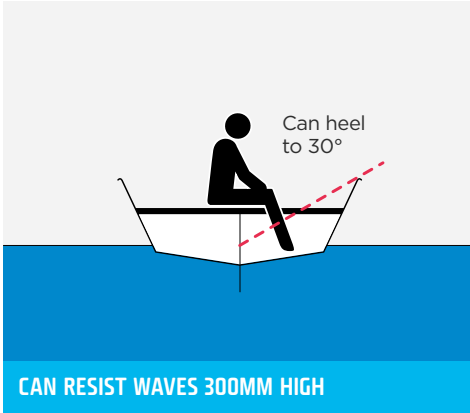

FLOTATION

The occupants of a swamped or flooded vessel will have a greatly improved chance of survival if it remains floating, upright and level. This can be achieved by correctly sized and fitted internal buoyancy because it:

- minimises the occupants' immersion in water, avoiding drowning and hypothermia
- provides access to the vessel's safety equipment, such as flares, radios, EPIRB or torch

- provides a larger target for searchers to see (a vessel is easier to see than people in the water)
- provides some shelter from wind and weather.

Many vessels, if full of water, may not have sufficient buoyancy to support the crew. If your vessel does not have an Australian Builders Plate (ABP), or if the plate does not state that the vessel has level flotation, it may not have sufficient buoyancy. This can even apply to relatively new vessels as the ABP has only been required in Victoria since 2012.



Basic flotation

A vessel that is fitted with basic flotation is not designed to support passenger weight when flooded. It may float at any orientation allowing occupants to hold, or climb onto, the upturned hull.



Level flotation

Level flotation is when a boat continues to float in an upright position that allows occupants to remain in the vessel, in calm water, and possibly bail it.

BOATING WITH CHILDREN

Many children love boating and other water activities. You can improve their confidence—and your peace of mind—by investing some time in training and education before you hit the water.

- Show children around the vessel—especially where PFDs, the first aid kit and other equipment are kept.
- Teach them emergency procedures, particularly that if the boat capsizes everyone should stay with it or an easily seen floating object.
- Teach them about stability, getting on and off the boat, and distributing the load evenly.
- If they are old enough, show children how to use safety equipment such as the radio, EPIRB and flares.
- Before you take them boating, encourage children to learn to swim, and practise emergency positions in the water, such as treading water, HELP (heat escape lessening posture) and Huddle.

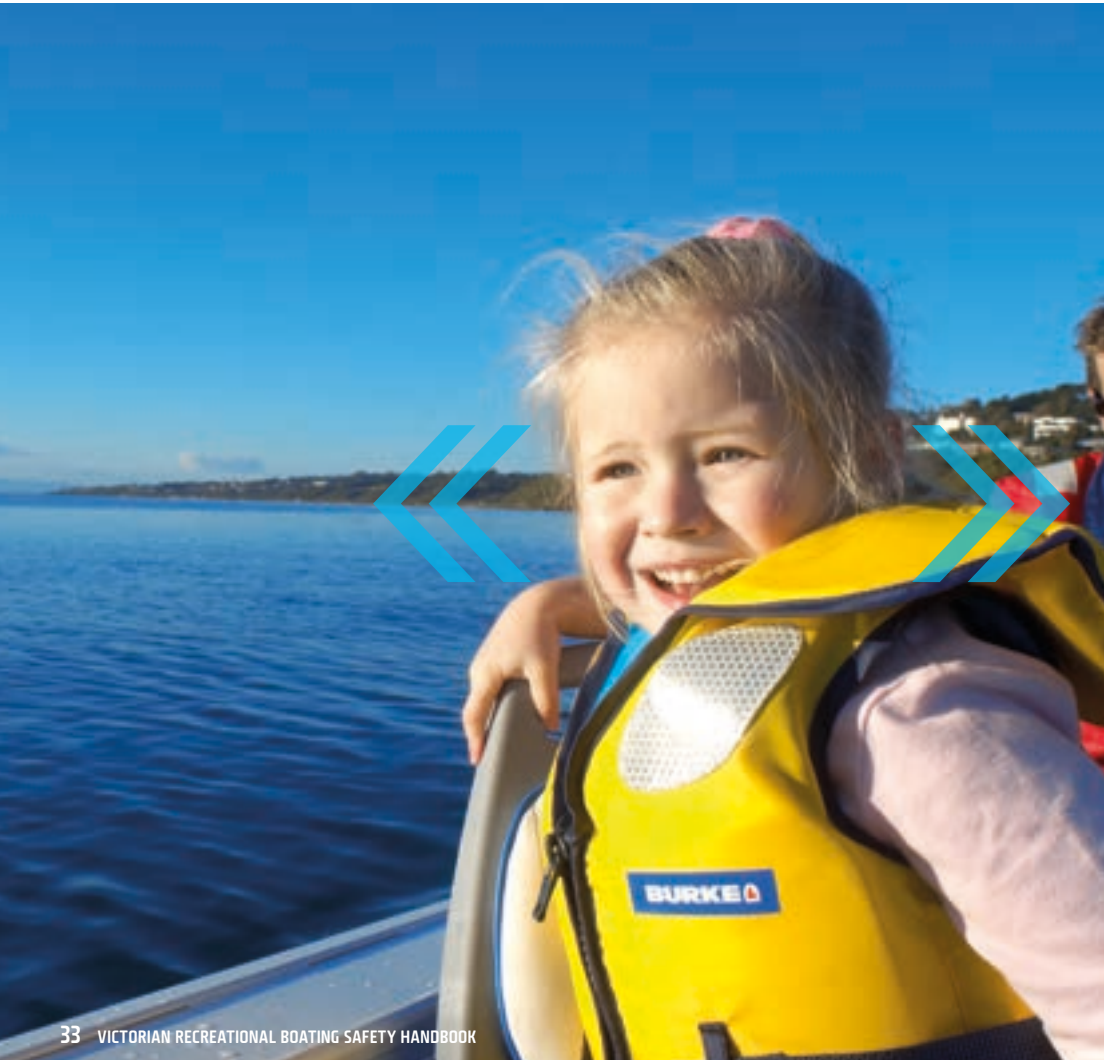

HEIGHTENED RISK

Recreational boaters are at heightened risk when they are in a vessel that is underway and is:

- crossing or attempting to cross an ocean bar (see page 56), or operating within a Designated Hazardous Area (see page 8)
- being operated by a person who is the only person on board the vessel
- being operated during the period commencing one hour after sunset and ending one hour before sunrise
- disabled
- a yacht where no safety barriers lifelines, rails, safety harnesses or jacklines are in use
- being operated during a period of restricted visibility
- being operated in an area where a current warning of the following kind has been issued by the Bureau of Meteorology:
 - gale warning
 - storm force wind warning
 - hurricane force wind warning
 - severe thunderstorm warning
 - severe weather warning
- when there is significant likelihood that the vessel may capsize or be swamped by waves or the occupants of the vessel may fall overboard or be forced to enter the water
- when there is a restriction on the ability to anticipate such an event, such as when a hazard cannot be seen
- up to and including 4.8 metres, and are in an open area of the vessel.

Heightened risk is not limited to when the vessel is underway. When launching and retrieving, vessels are often in restricted areas and the risk of being nudged by another vessel or bumping into a jetty or other object is high.

What does underway mean?

Underway means not at anchor, not made fast to the shore, or aground. If you are drifting you are underway. Vessels travelling at any speed are at risk of being involved in an incident resulting in the occupants unexpectedly entering the water.

While launching or retrieving, a vessel being driven off or onto a trailer is considered to be underway if it is on water.

When are you considered the only person on the vessel?

You are considered to be the only person on the vessel when you are boating with a child or someone of limited strength or mental capacity.

If there is another person on board with you, they must be capable of:

- manoeuvring the vessel around to get you if you are in the water
- pulling you back on board if you fall out of the vessel and cannot help yourself
- returning the boat to the jetty or beach if you are incapacitated
- calling for help when necessary.

What is meant by an open area of a recreational vessel (excluding kayaks and canoes)?

- All deck areas including coach roofs, superstructures, open fly bridges, trampolines and nets, but excluding areas within a rigid deckhouse, a rigid cabin, a rigid half-cabin or a securely enclosed under-deck space.
- For vessels without a deck, the whole vessel, excluding areas within a rigid cabin, rigid half cabin or a securely enclosed space.

Reducing risk

During times of heightened risk, it is critical that you know how to handle your vessel and know what safety equipment you need, particularly what lifejacket you need to wear. Use the lifejacket selector at wearalifejacket.vic.gov.au

It is extremely difficult (and in some circumstances impossible) to put a life jacket on if you are in the water. Avoid this situation by wearing your life jacket at all times and requiring the occupants of your vessel to do so.

SAFETY EQUIPMENT

The minimum safety equipment requirements vary under the MSA depending on the class of vessel being operated, and in which areas and types of waterways it's operated.

The tables overleaf show the minimum safety equipment that must be carried on board each class of vessel, such as powerboat, yacht or human powered vessels.

See Lifejacket Wear section (page 45) for lifejacket types.

SAFETY EQUIPMENT EXEMPTIONS

A person operating a vessel on Victorian waters who normally resides outside Victoria is exempt from carrying the prescribed safety equipment for a period of up to three months provided the vessel complies with the safety equipment requirements of their home state or territory.

All interstate visitors must comply with the requirements to wear personal flotation devices (lifejackets) under the conditions required in marine safety law.

SAFETY EQUIPMENT MAINTENANCE AND PLACEMENT

All safety equipment worn or carried on board must be:

- easily accessible
- kept in good working condition
- maintained or serviced in a way that ensures it can be operated in the way that it was designed to be operated, and
- serviced on or before the date specified by the manufacturer.

LENGTH OF VESSEL

The length of a vessel is important to know when estimating:

- vessel carrying capacity
- the number of fire extinguishers to be carried
- when lifejackets are to be worn when in an open area of a vessel that is underway.







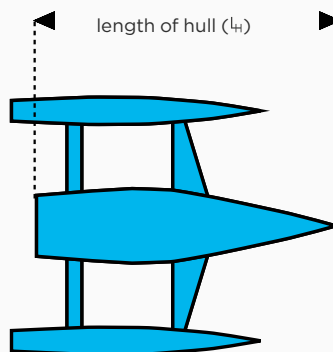
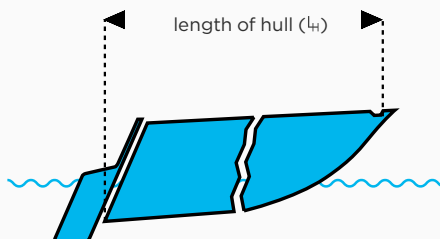
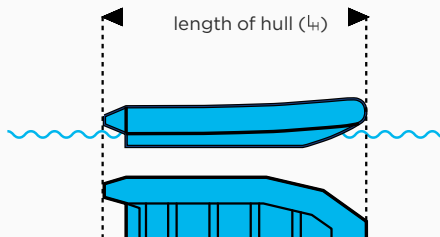
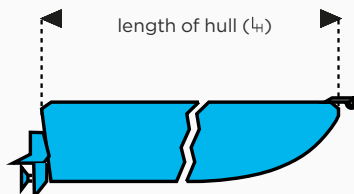









The length of vessel means the length of the hull (LH) and it determines the safety equipment requirements for your vessel. This includes all structural and integral parts of the craft, such as wooden, plastic or metal stem or sterns, bulwarks and hull/deck joints. This length excludes removable parts that can be detached in a non-destructive manner without affecting the structural integrity of the craft, for example, outboard motors, swimming platforms, bowsprits, fittings or attachments.





You are at heightened risk at all times when you are in an open area of a vessel that is underway and the vessel is up to and including 4.8 metres.



















SAFETY EQUIPMENT CARRIAGE CHECKLIST – POWERBOAT

POWERBOAT	Coastal offshore (>2 nm from coast)	Coastal inshore (<2 nm from shore)	Enclosed (bays and estuaries)	Inland (rivers, lakes and dams)
 Lifejacket (per person on board/towed)	Type 1	Type 1	Type 1	Type 1, 2 or 3
 Approved fire extinguisher	Where any fuel is carried, refer to fire fighting equipment tables in this chapter on page 44 to determine number and capacity required.			
 Waterproof buoyant torch	1	1	1	1
 Anchor and chain or line or both	1	1	1	
 Bailer (if no electric or manual bilge pumping system)	1	1	1	1
 Bucket with lanyard (can also double as a bailer)	1	1	1	1
 Electric or manual bilge pumping system (if vessel has covered bilge or closed underfloor compartments other than airtight void spaces)	1	1	1	1
 Pair of oars with rowlocks or pair of paddles (if vessel is up to and including 4.8 m)	1	1	1	1
 Hand held orange smoke signals	2	2	2	
 Hand held red distress flares	2	2	2	
 Lifebuoy (if vessel is more than 8 m but less than 12 m in length)	1	1	1	1
 Lifebuoy (if vessel is more than 12 m in length)	2	2	2	2
 Dinghy or liferaft (if vessel is more than 12 m in length)	1	1		
 Compass	1			
 Marine radio	1			
 Red star parachute distress rocket	1			
 Registered EPIRB	1			

SAFETY EQUIPMENT CARRIAGE CHECKLIST – PWC

PWC	All waters
 Lifejacket (per person on board/towed)	Type 1, 2 or 3
 Waterproof buoyant torch	1
 Registered EPIRB	1 if more than 2 nm from coast (coastal offshore)









SAFETY EQUIPMENT CARRIAGE CHECKLIST – YACHT

YACHT	Coastal offshore (>2 nm from coast)	Coastal inshore (<2 nm from shore)	Enclosed (bays and estuaries)	Inland (rivers, lakes and dams)
 Lifejacket (per person on board/towed)	Type 1	Type 1	Type 1 or 2	Type 1 or 2
 Approved fire extinguisher	Where any fuel is carried, refer to fire fighting equipment tables in this chapter on page 44 to determine number and capacity required.			
 Waterproof buoyant torch	1	1	1	1
 Anchor and chain or line or both	1	1	1	
 Bailer (if no electric or manual bilge pumping system)	1	1	1	1
 Bucket with lanyard (can also double as a bailer)	1	1	1	1
 Electric or manual bilge pumping system (if vessel has covered bilge or closed underfloor compartments other than airtight void spaces)	1	1	1	1
 Hand held orange smoke signals	2	2	2	
 Hand held red distress flares	2	2	2	
 Lifebuoy (if vessel is more than 8 m but less than 12 m in length)	1	1	1	1
 Lifebuoy (if vessel is more than 12 m in length)	2	2	2	2
 Dinghy or liferaft (if vessel is more than 12 m in length)	1	1		
 Compass	1			
 Marine radio	1			
 Red star parachute distress rocket	1			
 Registered EPIRB	1			







RECREATIONAL TENDER

All occupants on a recreational tender must wear a Type 1 lifejacket on coastal waters, a Type 1 or 2 on enclosed waters, and either a Type 1, 2 or 3 on inland waters.









SAFETY EQUIPMENT CARRIAGE CHECKLIST – OFF-THE-BEACH SAILING YACHT

OFF-THE-BEACH SAILING YACHT	Coastal offshore (>2 nm from coast)	Coastal inshore (<2 nm from shore)	Enclosed (bays and estuaries)	Inland (rivers, lakes and dams)
 Lifejacket (per person on board/towed)	Type 1	Type 1 or 2	Type 1 or 2	Type 1 or 2
 Bailer (if no electric or manual bilge pumping system)	1 if vessel is not self-draining without intervention from the crew			
 Electric or manual bilge pumping system (if vessel has covered bilge or closed underfloor compartments other than airtight void spaces)	1	1	1	1
 Hand held orange smoke signals	2			
 Hand held red distress flares	2			
 Compass	1			
 Marine radio	1			
 Red star parachute distress rocket	1			
 Registered EPIRB	1			

SAFETY EQUIPMENT CARRIAGE CHECKLIST – STAND UP PADDLEBOARD

STAND UP PADDLEBOARD	Coastal offshore (>2 nm from coast)	All other waters
 Lifejacket (per person on board/towed)	Type 1, 2 or 3	Type 1, 2 or 3 >400m from shore
 Waterproof buoyant torch	1	
 Hand held orange smoke signals	2	
 Hand held red distress flares	2	
 Compass	1	
 Registered EPIRB	1	

SAFETY EQUIPMENT CARRIAGE CHECKLIST – HUMAN POWERED VESSELS

HUMAN POWERED VESSELS (INCLUDING KAYAK, CANOE, RAFT AND ROWING BOAT)	Coastal offshore (>2 nm from coast)	Coastal inshore (<2 nm from shore)	Enclosed (bays and estuaries)	Inland (rivers, lakes and dams)
 Lifejacket (per person on board/towed)	Type 1, 2 or 3	Type 1, 2 or 3	Type 1, 2 or 3	Type 1, 2 or 3
 Waterproof buoyant torch	1			
 Bailer (if no electric or manual bilge pumping system)	1	1	1	1
 Electric or manual bilge pumping system (if vessel has covered bilge or closed underfloor compartments other than airtight void spaces)	1	1	1	1
 Spare oar with rowlock or spare paddle	1			
 Hand held orange smoke signals	2			
 Hand held red distress flares	2			
 Compass	1			
 Registered EPIRB	1			

SAFETY EQUIPMENT CARRIAGE CHECKLIST – FUNBOAT AND PEDALBOAT

FUNBOAT AND PEDALBOAT	All waters
 Lifejacket (per person on board/towed)	Type 1, 2 or 3

SAFETY EQUIPMENT FEATURES AND STANDARDS

This section outlines the minimum features and standards your safety equipment requires to perform as you expect when needed.

Lifejacket (also known as a personal flotation device (PFD)) standards

All lifejackets that are manufactured to comply with the Australian Standard, require legible markings that declare they meet the Standard.

Australian Standards Markings include:

- the manufacturer's name, trade name or trademark
- the words PFD TYPE 1 - or level 275, 150 or 100, PFD TYPE 2 - or level 50, or PFD TYPE 3 - or level 50 special purpose
- manufacturer's model identification, batch identification and year of manufacture
- intended body mass range
- illustrated instructions for donning the PFD
- instructions for storage and care
- information relating to replacement or checking of gas cylinders of inflatable PFDs. Lifejackets with a Standards Australia mark must also carry a label identifying the level number.

You can ensure your lifejackets are compliant with the Australian standards by shopping for jackets bearing the compliance marks of accredited certification bodies.



For a lifejacket to comply with a particular standard, certain information required under that standard must be displayed. The current Standard for life jackets is Australian Standard 4758 (AS 4758). This Standard has replaced Australian Standard 1512-1996, Australian Standard 1499-1996 and Australian Standard 2260-1996.

Some international lifejackets are now also accepted as alternatives to Australian Standards. To obtain a list of all accepted lifejackets visit wearalifejacket.vic.gov.au/lifejacket-laws

Beyond compliance

The safety equipment tables on pages 37-40 represent minimum requirements as described in the legislation (see Acts and Regulations section). You should make a safety assessment of your vessel operations and determine whether more equipment is required to take reasonable care of everyone's safety. Thinking beyond the minimum compliance requirements will also give you a better boating experience.

Although not prescribed under Victorian law, there are many extra items that the master of a vessel can carry on board their vessel that can be easily acquired and at reasonable cost. For example, it is recommended that you have:

- a first-aid kit
- adequate drinking water
- a basic tool-kit
- an EPIRB on all waters
- a PLB
- red, parachute rocket flares on all waters.

Anchors

An anchor is an important item of equipment and should be selected carefully. Choose an anchor that will suit your circumstances and the area of operation. The most common are:

DANFORTH



- recommended for small craft
- small, light, easy to handle
- excellent holding power, especially in sand, but may get caught on reefs.

PLOUGH



- suited to larger and heavier vessels
- excellent holding power, but best suited to mud; may get caught on reefs.

GRAPNEL



- flexible prongs (suitable for anchoring on reefs)
- suited to snag and rock conditions (for example, the River Murray)

SARCA (SAND AND ROCK COMBINATION ANCHOR)



- superb holding power
- multi-purpose—suited to mud, sand, gravel and rock bottoms not suited to snags (for example, the River Murray).

SEA ANCHOR OR DROGUE (NOT AN APPROVED ANCHOR)



- this may be anything that can be used for offshore boating to slow rate of drift, eg. a large bucket trailing behind the vessel (drogue) or from the bow (sea anchor).
- a sea anchor or drogue will not hold your vessel fast, so if using a sea anchor you must also carry an approved type of anchor.



ANCHOR LINE SELECTION TIPS

Consider the following points in selecting the line you will be using:

- don't use a line that floats such as polypropylene as it inhibits the anchor's ability to dig in and is prone to being cut by other propellers
- nylon and silver ropes have strength, stretching ability and resistance to abrasion, and don't easily float in water
- nylon is stronger than silver rope.

The use of a length of chain between the anchor and line is recommended. The purpose of the chain is to keep the shank of the anchor down as near as possible to parallel to the sea bottom. As a guide, the length of the chain should be approximately equal to the length of the vessel. For further information on anchoring, refer to the Anchoring section in the Safe Operation chapter.

Fire extinguishers

The master of a recreational vessel that carries fuel on board (excluding PWCs), or that is equipped with an electric start motor, gas installation or fuel stove, must ensure that:

- the vessel is equipped with the number of portable fire extinguishers prescribed (see table below)
- at least one of those portable fire extinguishers is of the minimum nominal capacity prescribed (see table below)
- one of the portable fire extinguishers is positioned adjacent to the engine and fuel carrying spaces of the vessel and is readily accessible
- when more than one fire extinguisher is required to be carried they must be located in separate positions on the vessel.

Fire blankets

If a vessel has cooking facilities located within an enclosed space on the vessel, the master of the vessel must ensure that a fire blanket is positioned in a conspicuous location and that it is readily accessible to a person using the cooking facilities.

A fire blanket must comply with Australian Standard AS/NZS 3504:2006 "Fire blankets".

Fixed fire extinguishing systems

In some circumstances, vessels fitted with a fixed fire extinguishing system can be exempt from the requirement to carry a portable fire extinguisher of the minimum nominal capacity.

A fixed fire extinguishing system must comply with International Standard ISO 9094-1:2003(E) Part 1 or 9094-2:2002(E) Part 2 'Small craft - Fire protection'.

NUMBER OF PORTABLE FIRE EXTINGUISHERS REQUIRED TO BE CARRIED ON A VESSEL

Vessel size	Number required
Less than 8 m	1 (of the minimum nominated capacity)
8 to 12 m	2 (one of the minimum nominated capacity)
More than 12 m	3 (one of the minimum nominated capacity)

MINIMUM CAPACITY OF PORTABLE FIRE EXTINGUISHERS ON A VESSEL

Volume of flammable or combustible liquids that are able to be carried on vessel	Minimum nominal capacity of fire extinguisher
Less than 115 litres	0.9 kg
115 to 350 litres	2.0 kg
351 to 695 litres	4.5 kg
More than 695 litres	9.0 kg

LIFEJACKET WEAR

Under marine safety law, you are required to wear a lifejacket in the circumstances listed below. Lifejackets must be correctly fastened when worn, otherwise penalties apply.

WHEN IN AN OPEN AREA OF A VESSEL THAT IS UNDERWAY

You are required to wear a specified lifejacket when in an open area of a vessel that is underway (see page 47) if you are an occupant of any of the following:

- a power-driven vessel up to and including 4.8 m in length
- an off-the-beach sailing yacht
- a personal watercraft (PWC)
- a canoe, kayak, raft or rowing boat
- a stand-up paddleboard, kiteboard or sailboard when more than 400m from shore
- pedal boat or fun boat
- recreational tender.

DURING TIMES OF HEIGHTENED RISK

All occupants of vessels listed above are to wear a specified lifejacket at times of heightened risk (see page 34) when in an open area of a vessel that is underway.

This also applies to occupants of the following vessels:

- yachts (including monohull, trailerable and multihull yachts but excluding off-the-beach sailing yachts)
- power driven vessels greater than 4.8 m and less than 12 m.

WEAR A LIFEJACKET WEBSITE

Try our lifejacket selector at wearalifejacket.vic.gov.au



LIFEJACKET TYPES

Lifejackets come in a variety of types with different characteristics and are also referred to as PFDs (personal flotation device).

Type 1 - Level 100 and over

A lifejacket Type 1 provides a high level of buoyancy and keeps the wearer in a safe floating position. They are made in high visibility colours with reflective patches.



Type 2 - Level 50

A lifejacket Type 2 is a buoyancy vest. It provides less buoyancy than a lifejacket Type 1 but sufficient to keep you afloat.



Type 3 - Level 50S

A lifejacket Type 3 is a buoyancy garment. It has similar buoyancy to a lifejacket Type 2 but is manufactured in a wide variety of colours and is shaped or equipped for particular activities.



The information below details the requirements for which specified lifejacket must be worn.

LIFEJACKET WEAR REQUIREMENTS			
VESSEL CLASS	COASTAL WATERS	ENCLOSED WATERS	INLAND WATERS
Powerboat up to and including 4.8 m in length	Type 1	Type 1	Type 1, 2 or 3
Powerboat more than 4.8m but not more than 12 m in length (at times of heightened risk)	Type 1	Type 1	Type 1, 2 or 3
Personal watercraft	Type 1, 2 or 3	Type 1, 2 or 3	Type 1, 2 or 3
Towed sport	A person who is being towed by a vessel must wear a lifejacket at all times.		
Recreational tender	Type 1	Type 1 or 2	Type 1, 2 or 3
Off-the-beach sailing yacht	Type 1 if >2 nm from coast, Type 1 or 2 if <2 nm from coast	Type 1 or 2	Type 1, 2 or 3
Yacht (at times of heightened risk)	Type 1	Type 1 or 2	Type 1, 2 or 3
Kiteboard or sailboard	Type 1, or 2	Type 1, 2 or 3	Type 1, 2 or 3
Canoe, kayak, rowing boat, raft, stand-up paddleboard, pedal boat or fun boat	Type 1, 2 or 3	Type 1, 2 or 3	Type 1, 2 or 3
	Please note: A person operating a stand-up paddleboard, kiteboard or sailboard no more than 400m from the shore, is not required to wear a lifejacket.		
Scuba or hookah diving equipment (underwater breathing apparatus of a kind that is self-contained (scuba) or is surface supplied)	A person who is wearing, or in the process of donning or removing, diving equipment is not required to wear a lifejacket.		

LIFEJACKETS ON CHILDREN

The master of a recreational vessel or a hire and drive vessel that is underway must ensure that every person aged less than 10 years old who is on an open area of the vessel wears a lifejacket at all times. Penalties apply when lifejackets are not worn. When choosing a lifejacket for a child, care must be taken to ensure that the garment fits the child and that small children do not slip out when they are in the water. Where possible, a child's lifejacket that features a crotch strap is strongly recommended, as it assists to hold the child in the jacket.

LIFEJACKETS ON BABIES AND TODDLERS

MSV does not recommend taking infants on board a recreational boat.

The varying weight distribution of babies means it is difficult to design jackets which have flotation in the right places to keep them afloat. The lifejackets currently available for newborns up to 10 kilograms may not provide a proper fit or perform as expected. You must be sure the lifejacket you have works for your infant. MSV recommends that children are not exposed to any risk on a boat on the water.



LIFEJACKET MAINTENANCE

Lifejackets must be maintained in accordance with manufacturers' recommendations to ensure the devices continue to operate the way they are supposed to. Refer to the manufacturers' website or information provided at time of sale for full servicing details relevant to your lifejacket.

Lifejacket style and maintenance

Inflatable lifejackets need to be inspected and serviced periodically, in order to comply with the legislation.

Buoyant lifejackets, such as foam lifejackets, should be self-inspected regularly. Check for mould, wear and tears.

Get to know your lifejacket

There are some simple checks that can be carried out regularly:

- Look over the jacket for any signs of physical damage that has occurred during storage or use.
- Make sure the indicator on inflatable lifejackets is green and that the CO2 cylinder is in good condition and screwed down tight on the 'O' ring.
- Check the lifejacket's fabric, flotation, zippers, buckles, waist belts and all fastenings for signs of excessive wear, cracking, fraying or anything to indicate possible loss of strength or flotation.

Self-inspection

A self-inspection is a yearly activity carried out by the owner of the lifejacket. See wearalifejacket.vic.gov.au/looking-after-your-lifejacket

Professional service

A professional service is carried out by an agent approved by the lifejacket manufacturer.

Most manufacturers provide a maintenance schedule including self-checking inspection and periodic servicing by an approved service agent.

If you have any concern, contact the manufacturer or place of purchase.



Remember that your lifejacket is a life saving device. Care for it as though your life depends on it. One day it might.

TRIP PREPARATION

Every accident or incident is unique but a common theme is that multiple things go wrong. Almost all incidents can be minimized or prevented completely with good pre-trip planning and by making good decisions.

Thorough preparation gives the master of a vessel the best opportunity to make good decisions while on the water.

The master of a recreational vessel should always undertake a safety assessment of the particular vessel and its intended operation. In addition to the minimum safety equipment carried in accordance with the MSR, the master should ensure the vessel is carrying any additional safety equipment that may be appropriate to control risks to acceptable levels.

- Get information about the area you are operating in, that is, how to get there, how long it will take, how to get back, and what safety or specialist equipment you may need.
- Check the sea conditions, tide levels, current, tidal and river flows, weather and bar conditions as appropriate.
- Find out about any local dangers and special rules or regulations for the area.
- Consider undertaking a coastal navigation course.
- Carry the appropriate chart for the area in which you will be navigating.

PRE-TRIP CHECK LIST

A thorough check of vessel, equipment and weather before each trip is recommended for safer boating. Download your pre-trip checklist flyer from the TSV website transportsafety.vic.gov.au/msv/trip-prep or obtain a hard copy from MSV, from information@transportsafety.vic.gov.au

LET SOMEONE KNOW BEFORE YOU GO

Always let someone know where you are going, your point of departure and when you plan to return. Agree on next steps or who to call if you haven't returned as planned. Also provide your contact person a description or photo of your vessel, vessel registration number and details of the number of passengers on board. This will assist emergency services, should the need arise. If your plans change, let someone know.

Download or request a handy 'I've gone boating' trip details flyer at transportsafety.vic.gov.au/msv/gone-boating

I've gone boating

HERE ARE MY TRIP DETAILS FOR (DATE): / /

I am departing at: _____ am/pm (please circle)

I am departing from: _____

My trip intentions are: _____

I will return no later than: _____ am/pm (please circle)

Number of people onboard (including me): _____

Weather expected: _____

Keep a whiteboard marker handy to enter fresh trip details and **ALWAYS** inform a relative or a friend of your boating plans by leaving them with this card. If you fail to return by the time specified they should **CALL 000 IMMEDIATELY**

 Ensure there is a PFD for everyone on board, appropriate for the area of operation.

 If things do go wrong, stay with your boat.

PLACE PICTURE OF YOUR BOAT HERE TO ASSIST POLICE WITH VESSEL IDENTIFICATION IN THE EVENT OF A SEARCH

VALUABLE INFORMATION ON THE BACK

STUDY THE WEATHER

Base your decision to go out on the water on the knowledge of what weather conditions you, others on board and your boat can handle.

Weather forecasts and warnings produced by the Bureau of Meteorology are available on all media. It is vitally important to be aware of the current weather conditions in the area you plan to boat in, and also how conditions will develop over the course of your trip – and a bit longer, just in case.

Internet

Visit bom.gov.au/marine for the latest weather charts, satellite and radar images as well as warnings and forecasts for the next four days. This site also provides links to tidal information, sunset and sunrise times as well as full schedules for all radio and phone services. Before heading out, run through the five vital weather safety checks to be prepared.

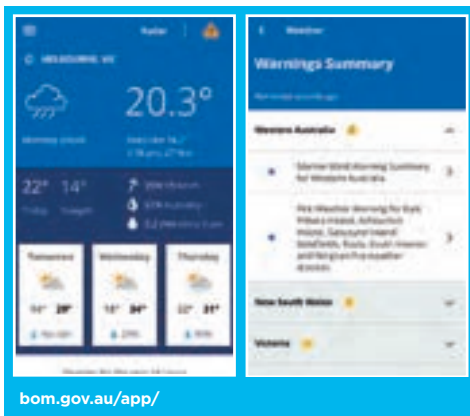
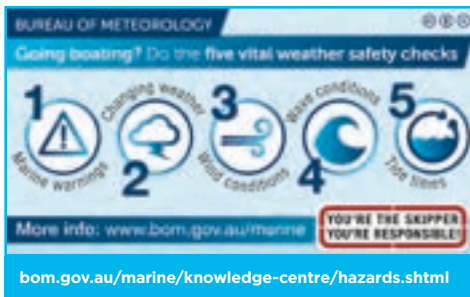

MetEye

MetEye shows the official forecasts produced by the Bureau of Meteorology in an interactive map. Forecasts are available for wind, waves, weather and much more in three hourly increments for up to seven days ahead.

Marine Lite

For boaters in areas of marginal mobile phone coverage, or whose offshore access is limited to satellite internet communication channels, text only webpages of the Bureau's Marine forecasts and warnings are provided at bom.gov.au/marine/lite.

VHF Radio weather services

Marine Radio Victoria (MRV) provides twice daily local weather forecasts on VHF radio, with instructions and broadcast times announced regularly on Channel 16. MRV also broadcast current weather warnings at 00:47, 02:48, 04:48, 06:48, 08:48, 10:48, 12:48, 14:48, 16:48, 18:48, 20:48 and 22:48 eastern standard time (EST) on VHF channel 67 following the initial broadcast until notice of the cancellation is received by the Bureau of Meteorology.

The Bureau of Meteorology broadcasts weather forecasts to eastern Australia from Charleville Radio on:

8176 and 12365kHz – all hours, 4426 and 16546kHz – all day (7am-6pm) and 2201, HF 6507kHz – by night (6pm-7am)

Scheduled broadcast times for Victorian coastal waters are: 0130, 0530, 0930, 1330, 1730 and 2130 EST (add one hour for EDST).

Warnings are broadcast every hour starting 0000 EST.

Please refer to transportsafety.vic.gov.au/msv/radio for more information on Marine Radio Victoria.

WEATHER HAZARDS AND CONDITIONS

Check the weather forecasts and warnings, which are regularly updated and give warnings of strong winds and gales. Sudden squalls are not easy to predict in Victoria, so keep a sharp lookout and regularly check the horizon for tell-tale clouds or whitecap waves.

If caught out in bad weather head for sheltered water, for example, the shore or the protected side of an island.

If possible, head into the wind and waves at a steady speed.

Squalls usually last only for a short period. It is often best to ride them out, keeping your bow into the wind and maintaining a speed sufficient to give you steering. Don't let the vessel drift side on to the wind and waves, your vessel may take on water or capsize.

BE PREPARED

Weather conditions on Victorian waters can change very quickly and a hot day can deteriorate into a cold and windy one.

Be prepared by:

- taking warm clothing
- knowing what to do in reduced visibility
- understanding what the clouds tell you about wind direction and strength
- having a global positioning system (GPS), charts and maps to help you navigate
- recognising that weather changes can create a situation of heightened risk.



If your vessel does not have power or anchor, drag a sea anchor from the bow, keeping the bow into the wind and waves. A sturdy bucket or oar on a rope may make an adequate sea anchor.

KNOW WHAT THE FORECAST IS TELLING YOU

Wind can change direction and strength very quickly. It is important to understand the key terms when reading a weather report.

- Wind speed over the water is given in knots. Wind mentioned in forecasts refers to the average wind over a 10 minute period at a height of 10 m.
- Gusts are increases in wind speed lasting for just a few seconds. They typically range 30-40 per cent greater than the average wind speed.
- Squalls are a sudden large increase in wind speed (usually accompanied by a change in wind direction) that lasts several minutes and then suddenly dies.

The Bureau of Meteorology issues a:

Strong wind warning

For winds averaging more than 25 knots and up to 33 knots

Gale warning

For winds averaging 34 knots and up to 47 knots

Storm warning

For winds averaging 48 knots or more



Maritime Safety Victoria strongly advises operators of small craft not to go boating when one of the above weather warnings has been issued.

The Bureau of Meteorology's marine forecasts describe mean conditions over reasonably large areas such as Northern Bass Strait or Port Phillip. Reference to squalls and thunderstorms alert vessel operators to adverse weather conditions

expected for short periods of time within the forecast period. Forecasts may not reflect local conditions where topographic influences might channel or block wind and affect wave development. Vessel operators should be familiar with local variations in certain wind streams before venturing out – ask the locals for advice.

WAVES

Wave heights mentioned in forecasts refer to significant wave height – being the average of the highest one third of waves. Larger waves do occur, especially in regions where tides and currents oppose wind-driven wave direction. Be aware of offshore winds and changes in wave height as you get further offshore i.e. Altona below.

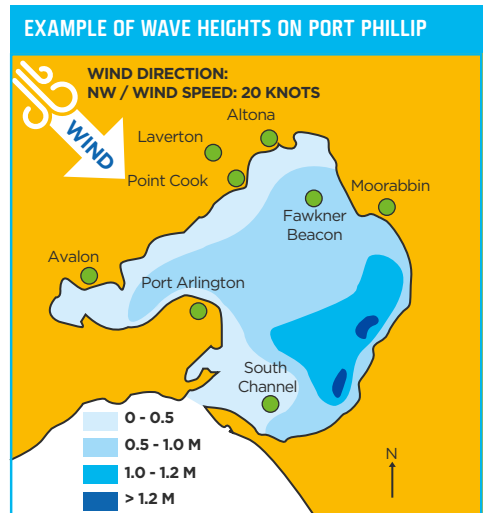
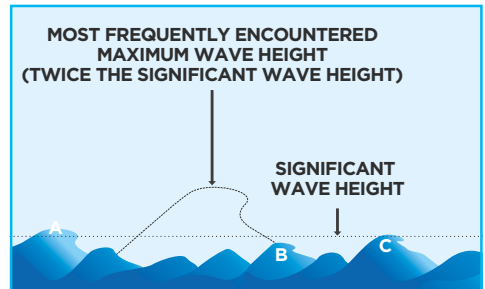

THUNDERSTORMS

Thunderstorms are a serious hazard for boats. Cumulonimbus or thunderstorm clouds (see diagram) produce strong, gusty winds that blow out from the front of the storm. If you see this type of cloud, you should watch which way it is moving – clouds often move in different directions from the wind at the surface. If it looks like it will pass over or within a few kilometres of you, head for shore immediately.

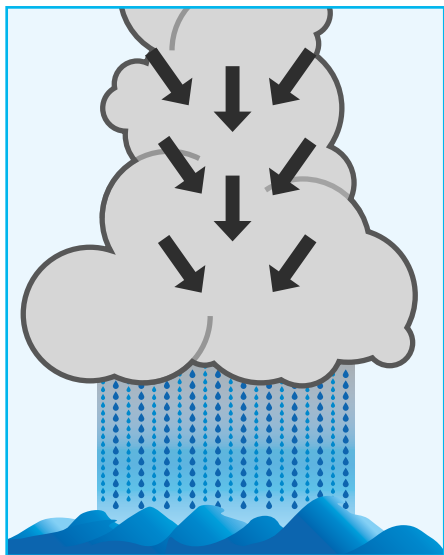

Safety hints

- Ensure you are carrying the prescribed safety equipment.
- Ensure you wear a lifejacket where required and consider wearing a lifejacket at all times while operating a vessel.
- Know the local factors that influence sea conditions and know where shelter can be reached quickly.
- Learn how to read the weather map.
- Be aware that the weather map in the morning newspaper was drawn the day before.
- Always check the latest forecast and warnings before going to sea and know what conditions exceed your safety limits.
- Beware of rapidly darkening and lowering cloud – squalls may be imminent.
- When at sea, listen to the weather reports on public or marine radio.
- Be flexible – change your plans if necessary.
- Be prepared to head back to shore regardless of how far you have travelled.
- Be prepared for changes in conditions and take warm clothing.

OFFSHORE WINDS

In offshore winds, sea conditions deteriorate the further you are from the shore. The relatively smooth conditions at the water's edge are not true indications of the conditions further out. Wave size and whitecaps may not be visible as you are viewing the backs of the waves. Strong offshore wind conditions may prevent you from being able to make your way back to the shore. These hazards increase significantly when operating in offshore winds in remote locations and on large expanses of water.

Safety hints

- Know your location and the risks involved - choose a suitable location for your activity and understand how the wind direction and sea conditions impact on the safety of that location (seek local knowledge from someone if you are unfamiliar with the location).
- Check the weather when planning your activity as well as on the actual day (before you head out).
- If operating near the coast understand the effects of topography on the wind and know how to identify the lee (wind shadow) visually.
- Know your limitations and that of your craft and equipment and ensure they are suitable for the expected conditions and your planned activity.
- Do not rely on minimum safety equipment requirements.

LOCAL KNOWLEDGE

In addition to complying with the appropriate Victorian boating legislation and requirements, it is important to find out if there are any special local rules. Seek advice on local conditions and carry the appropriate navigational chart of the area in which you will be navigating. Maps are available that show shallow areas by figures or colours and give accurate details of launching ramps and anchorages. Contact local waterway managers for local requirements.

NAVIGATIONAL CHARTS

It is recommended that vessels carry a navigational chart of the waters they are navigating. Navigation charts should:

- be suitable for navigation purposes
- be up to date
- help the operator plot a course or destination
- identify navigation features including the location of shipwrecks and other submerged hazards, depth of water, and the location of islands and hidden reefs
- show details such as navigation beacons and markers to harbours and channel entrances, transit zones and channels.

GPS plotters, while useful, should never be relied on as the sole means of information regarding your position and course. A chart can help to determine your position which can be of importance in an emergency.

CROSSING OCEAN BARS

The MSR defines an ocean bar as an area in state waters comprising a ridge of sand or gravel near or slightly above the surface of the water that:

- is located near or at the entrance to the sea from a bay, inlet, river or other waterway
- extends across the mouth of that bay, inlet, river or waterway or parallel to the shore
- is permanent or occurs from time to time.

This includes all waters within 500m of the ridge/bar.

There are many bar crossings in Victoria, including the entrances to:

- Andersons Inlet
- Lakes Entrance
- Marlo
- Barwon Heads
- Mallacoota
- McLoughlins Beach

The MSR requires that a lifejacket must be worn on certain recreational vessels and hire and drive vessels during times of heightened risk, such as when crossing or attempting to cross an ocean bar.

Contact local water police, port authorities, waterway managers, fishing and boating clubs, tackle shops, chandleries and commercial operators for advice on bar conditions and peculiarities. Assess weather conditions and obtain tide information. Observe local operators crossing the bar but do not cross if you are not adequately prepared.

EXERCISE EXTREME CAUTION

- Conditions on a bar change quickly and without warning.
- No amount of experience or boat type makes crossing a bar safe.

BE AWARE

- Night crossings are more hazardous.
- Vessels attempting to cross a bar at, or near, low water are more likely to experience adverse conditions.

PREPARING TO CROSS A BAR

- Ensure deck openings, hatches and doors are securely battened down.
- Stow all loose gear and put on lifejackets if you aren't already wearing them.

CROSSING A BAR

- Monitor the:
 - prevailing wind
 - wave pattern timing, that is, look for sets
 - course to follow
 - bar traffic
 - alternate routes.
- Motor slowly toward the breaking waves looking for the area where waves break least or not at all.
- If there seems no break in the waves, slowly power through each oncoming wave.
- Ensure that you are not going too fast over each wave as this would cause the vessel to 'bottom out' if it dives heavily.
- If possible, make the crossing with the waves slightly on the bow so that the vessel gently rolls over the crest of each wave.
- When approaching from sea, increase power of the vessel to catch up to the bigger set of waves and position the vessel on the back of a wave. Do not surf down the face of a wave

More advice at [transportssafety.vic.gov.au/msv/ocean-bars](https://www.transportssafety.vic.gov.au/msv/ocean-bars)



Crossing bars can be dangerous. Make sure you are adequately prepared. If in doubt, don't go out.

Safe boating on NSW waterways

When it comes to the Murray River, which borders Victoria and New South Wales, the laws of NSW apply

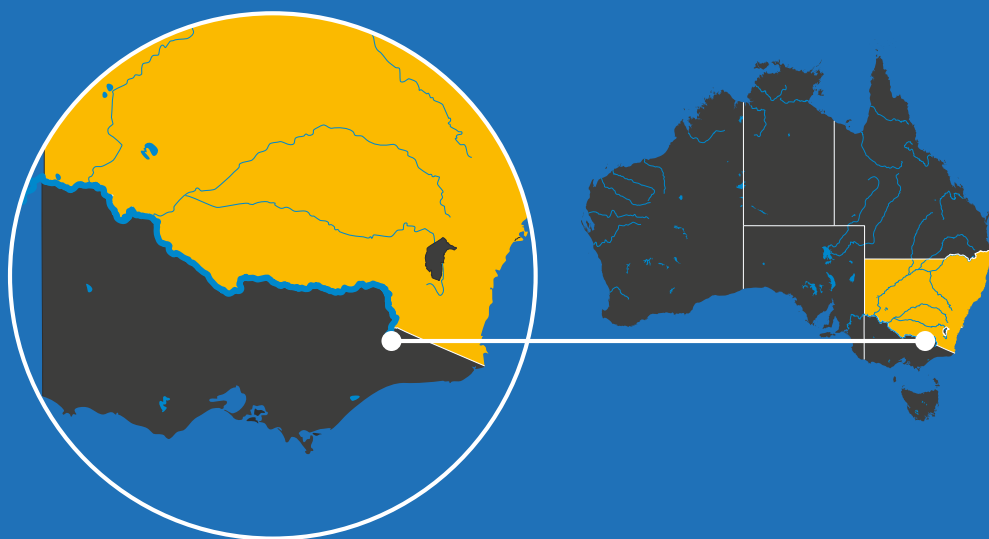

INTERSTATE BOATING

When boating interstate you are required to adhere to the safety and operating rules imposed by that state. Victorians visiting other states or territories should contact the relevant local authority prior to travel to ensure compliance with safety equipment and other operating requirements.

Wear a lifejacket

In NSW, appropriate lifejackets must be carried for everyone on board (in most cases) and they must be worn in a range of situations on different types and sizes of vessels and at times of heightened risk. For example, children under 12 years old must wear a lifejacket at all times on vessels less than 4.8 metres and in open areas of vessels under 8 metres while underway.

If using inflatable lifejackets, they must be serviced at least annually or in accordance with the manufacturers' instructions.

Additional lifejacket rules apply. To find out more visit rms.nsw.gov.au/lifejackets

Keep a safe distance and speed

All vessels must travel at a safe speed for the prevailing conditions and keep a safe distance from people in the water, other vessels, structures and the shore at all times. You must also observe any signposted speed limits.

In NSW, when travelling in a power-driven vessel at six knots or faster, you must keep at least 30 metres from other vessels, structures and the shore. When driving any vessel at any speed, you must keep at least 60 metres from people in the water and any dive flag. If these are not possible, a safe distance and speed must be maintained.

Other safe navigation tips include:

- Keeping a proper lookout at all times
- Using appropriate navigation lights at night
- Keep to the right side in rivers and channels. On lakes, the direction of travel is anti-clockwise unless otherwise stated.

If in doubt, consult the relevant waterway manager and follow authorised signage.

Personal watercraft

In NSW, you must hold a PWC licence to drive a PWC. Operators and passengers must wear approved lifejackets at all times. PWC use is prohibited between sunset and sunrise in NSW.

Go easy on the drink

Both states have strict limits on blood alcohol levels for recreational boat operators. Don't go boating under the influence of alcohol.

In NSW, the maximum permissible blood alcohol limits are 0.00 for operators aged under 18 years and under 0.05 for those over 18 years.

When engaged in tow sports, alcohol limits apply to drivers, observers and everyone being towed.

Tow safe

Everyone being towed must wear an appropriate lifejacket and no more than three people may be towed simultaneously.

In NSW, observers must hold a boat or PWC driving licence or be 16 years of age or older.

Safe distance requirements apply at any speed to both the vessel and the person being towed. Towing is prohibited between sunset and sunrise.

Consider the impact of your vessel's wash on other people and the environment. Ensure your wash does not have a dangerous, damaging or unreasonable impact.

For more information contact Roads and Maritime Services rms.nsw.gov.au maritime or call 13 12 36

ENVIRONMENT AND WILDLIFE

Help protect the environment by observing the following common sense rules:

- launch and retrieve your boat at designated boat ramps
- reduce your vessel speed to five knots near the edge of lakes and rivers
- dispose of all rubbish including fishing line, bait bags and food scraps appropriately
- use sewage disposal facilities and prevent pollutants such as petrol and oil from entering the water.

Further information is available from local offices of the Department of Environment, Land, Water and Planning (DELWP). Visit delwp.vic.gov.au or call **136 186**.

WHALES, DOLPHINS AND SEALS

It's important not to get too close to marine mammals when on the water. This is to reduce the risk of disturbance to natural behaviours.



- **boats are not permitted to approach within 100 m of a dolphin or 200m of a whale**
- **jet skis are not permitted within 300m of either a whale or dolphin.**

More stringent requirements apply in relation to narrow waterways (being a waterway of less than 300m in width at its widest point).

To learn more about the restrictions in place for boating and swimming around whales, dolphins and seals, contact DELWP.

RECREATIONAL FISHING REGULATIONS

Ensure you have a current copy of the Victorian Recreational Fishing Guide or have downloaded the 'Vic Fishing' app for smartphones. Visit the Victorian Fisheries Authority (VFA) website vfa.vic.gov.au

Report illegal fishing anytime by calling **13FISH (13 3474)**

AQUACULTURE FISHERIES RESERVES

Nine offshore marine aquaculture fisheries reserves have been established in and around Port Phillip, marked by navigation aids with 'Aquaculture' written on the yellow 'X' cross bar (see picture).

They are lit at night. Recreational users in surrounding waters should proceed with caution if near or entering the reserves to prevent damaging your vessel and the long lines of nylon rope suspended on buoys used in these areas.



Aquaculture fisheries reserves (AFR)

1. Grassy Point AFR
2. Clifton Springs AFR
3. Bates Point AFR
4. Kirk Point - Werribee AFR
5. Beaumaris AFR
6. Mount Martha AFR
7. Pinnacle Channel AFR - Southern Section
8. Pinnacle Channel AFR - Northern Section
9. Flinders AFR
10. Dromana AFR

BASS STRAIT



MARINE NATIONAL PARKS AND MARINE SANCTUARIES

The Victorian Government has created 13 marine national parks and 11 smaller marine sanctuaries to ensure that representative samples of Victoria's marine environment are conserved for future generations.

RESTRICTIONS

All forms of commercial and recreational fishing from sea or shore in Marine National Parks and Marine Sanctuaries are prohibited, including collecting bait, line fishing, setting traps, netting and the use of spears. Heavy penalties apply.



No fishing, netting, spearing, taking or killing of marine life is permitted including all methods of fishing, from the shore or at sea in Marine National Parks or Marine Sanctuaries.



Taking or damaging animals, plants and objects (artefacts) is also not permitted. There are strong penalties under the *National Parks Act 1975 (Vic)* for fishing in marine national parks and marine sanctuaries.

BOUNDARY MARKERS

Yellow on-shore triangles

These are located at the park boundaries and point in towards the marine national park or marine sanctuary. In some cases there are two yellow on-shore triangles located on separate poles, one taller than the other. These two triangles can be used to get a lead to the boundary by aligning them so one is seen to be directly above the other.

Yellow in-water special mark

These markers are found on buoys and piles and are used to mark the boundaries of zones and other special areas.

PUBLICATIONS AND FURTHER INFORMATION

Parks Victoria is responsible for the day-to-day management of Victoria's marine national parks and marine sanctuaries. If you would like further information about these, please contact the Parks Victoria Information Centre on **131 963** or visit parkweb.vic.gov.au. On-site signage at key access points, for example, boat ramps, is also provided.

ENVIRONMENT PROTECTION

Some boating activities can have a significant impact on water quality.

For example, the discharge of waste from boats may add nutrients and pollutants to our waterways and can pose a risk to ecosystems and human health. The discharge of oil, chemicals, sewage, garbage, litter or any other waste is prohibited in any waters in Victoria.

To report a waste or pollution incident, contact the Environment Protection Authority (EPA) on **1300 372 842** or visit epa.vic.gov.au

CHAPTER 2

SAFE OPERATION





SPEED AND DISTANCE RULES	67
HOON LAWS	68
ALCOHOL AND DRUGS	68
TRANSIT ONLY ZONES AND CHANNELS	69
KNOW THE COLLISION REGULATIONS	70
Rule 5 – Keeping a proper lookout	70
Rule 6 – Every vessel shall proceed at a safe speed	71
Rule 7 – Risk of collision	71
Rule 8 – Action to avoid a collision	71
Rule 9 – Narrow channels	71
Rule 12 – Sailing vessels approaching one another	72
Rule 13 – Overtaking	73
Rule 14 – Head on situation – each vessel to steer to starboard	73
Rule 15 – Power driven vessels crossing situation	74
Rule 18 – Responsibilities between vessels	75
Rule 19 – Restricted visibility	76
BUOYAGE IALA SYSTEM A	77
IALA System A light rhythm types	77
Direction of buoyage	78
BUOYAGE TYPES	79
Lateral marks	79
Cardinal marks	81
Special marks	83
Isolated danger marks	83
Safe water marks	84
New danger mark	84
BOATING ZONE BUOYAGE (INLAND WATERWAYS)	85
Red mini buoy	85
Green mini buoy	85
Yellow mini buoy	85
Red and yellow mini buoy	85
BOATING ZONE MARKS AND SIGNAGE	86
NAVIGATION LIGHTS	86
Operating at night	87
Vessel navigation lights to be displayed	88
DAY SHAPES FOR VESSELS	95
SOUND AND LIGHT SIGNALS	98
Definitions and classifications	98
Sound signals for vessels in restricted visibility (day and night)	99

BASIC BOAT HANDLING TIPS

- Launching
- Berthing and unberthing
- Anchoring
- Mooring
- Retrieving

100
100
101
102
103
104

TOWED WATER SPORTS

- Observer
- Towing safely
- No wash zones
- Access lanes
- Hand signals

105
105
105
107
107
108



SPEED AND DISTANCE RULES

Speeding is a key risk factor on Victoria's waterways. Speeds are limited by law in specific boating areas to address safety concerns arising from competing and/or conflicting use. Speed measuring devices can be used to detect speeding vessels. All speeds are measured in knots for the purpose of the *Marine Safety Act 2010* (Vic) (MSA) and the *Marine Safety Regulations 2012* (Vic) (MSR).

Five knots is considered to be a fast walking pace.

Note: The five knot speed limit does not apply to boat and PWC operators when:

- i. within an exclusive area prescribed in a Schedule to a Notice which is set aside for a specific activity under Clause 13 of the Vessel Operating and Zoning Rules (VOZR) in which the width of water prevents the keeping of distance
- ii. engaged in competition or training organised in accordance with the rules of a Victorian sporting organisation or that has been approved in writing by the Safety Director.

On ALL Victorian waters a 5 knot speed limit applies to boat operators and PWC operators within a distance of:

50 m of a person, vessel, fixed or floating structure and the shore on inland waters

50 m of a person, vessel, wharf, jetty, slipway, diving platform or boat ramp on coastal and enclosed waters

100 m of a dive flag 

200 m of the shore on enclosed and coastal waters

or as per the scheduled waterway rules



In addition, on all Victorian coastal and enclosed waters, or bays, a 5 knot speed limit applies to boat operators and PWC operators under the following conditions:

within 200 m of the water's edge unless specifically excluded by Notice or where designated for other purposes

within 50 m of any wharf, jetty, slipway, diving platform or boat ramp

when passing through a recognized anchorage for small vessels.



In addition, on all Victorian inland waters a 5 knot speed limit applies to boat operators and PWC operators within:

50 m of the water's edge unless the local authority specifically excludes those waters by Notice or they are designated for other purposes

50 m of any fixed or floating structure



HOON LAWS

A person must not operate a recreational vessel (including PWCs) or hire and drive vessel at a speed or in a manner which is dangerous to the public, birds and marine animals.

A member of the Victoria Police may seize, impound or immobilise a vessel, if they believe on reasonable grounds that a recreational vessel is being or has been used in the commission of a relevant offence.

In addition, Victoria Police and Transport Safety Victoria officers have the power to embargo and prohibit the use and operation of a vessel.

ALCOHOL AND DRUGS

Alcohol affects your sensory abilities and decreases your reaction time. As with driving a car, alcohol and drugs may affect boaters':

- depth perception and ability to see other boats and judge speed and direction
- peripheral, colour and night vision
- balance and coordination
- comprehension and concentration
- fatigue levels

Loss of judgment and coordination and increase in reaction time can lead to the inability to react appropriately to a dangerous boating situation.

Drink driving laws are strictly enforced for the safety of all.

Victoria Police officers are empowered to use breathalysers to help detect operators exceeding alcohol limits. Heavy penalties apply to offenders.

Alcohol increases body-heat loss, reducing your survival time if you fall overboard. It also increases the pulse rate, leading to rapid exhaustion in survival situations.

Prescribed medications and other drugs can also pose problems. Many preparations for seasickness, hay fever and other allergies can make you feel drowsy or easily confused.

Before you go boating, check with your doctor or chemist on the possible side effects of any drugs you take.

Persons under 21 who operate a vessel or who are in charge of a vessel, including one at anchor, must not have any alcohol present in their blood or breath, that is, a reading of 0.00%.

Persons over 21 operating or in charge of a vessel must not have a blood or breath alcohol reading over 0.05%. This is in line with the rules that apply to drivers.

It is an offence for any person to operate or be the master of a vessel, including one at anchor, who is under the influence of alcohol or any other drug to such an extent as to be incapable of having the proper control or directing the proper operation of a vessel. It is also an offence to operate or be the master of a vessel:

- while the prescribed concentration of drugs (which has the same meaning as in the *Road Safety Act 1986* (Vic)) is in a person's blood or oral fluid; or
- while impaired by a drug.

Please refer to the *Marine (Drug, Alcohol and Pollution Control) Act 1988* (Vic) for details on alcohol and drug related offences.

TRANSIT ONLY ZONES AND CHANNELS

A transit only zone is a regulated area of water in the vicinity of a commercial shipping channel or fairway. Small boat operators must not anchor, moor, drift or engage in fishing activities within a transit only zone. The purpose of designating a transit only zone is:

- to avoid potential collisions between small boats and large commercial ships
- for the safety of small boat operators and their passengers.

A transit only zone in Port Phillip Bay extends from Point Gellibrand (Williamstown) south to an imaginary line at latitude 38° South.

Yellow 'special mark' light buoys are used to define the boundary zone (see map).

Shipping channels and their approaches are high shipping hazard areas. Small boat operators should exercise caution and steer well clear in these areas.

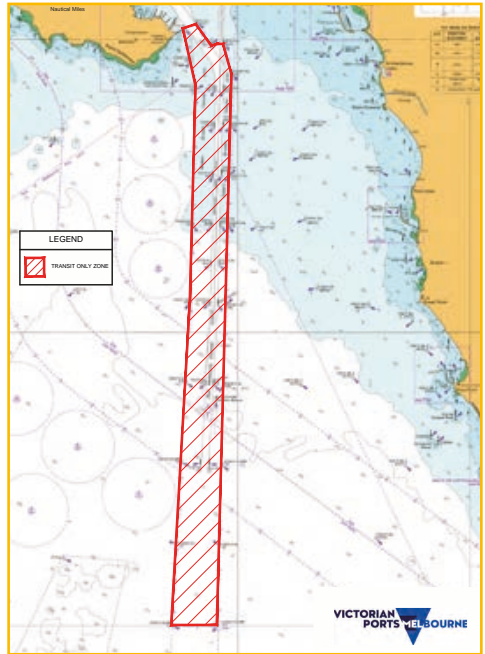

KNOW THE COLLISION REGULATIONS

The International Regulations for Preventing Collisions at Sea, 1972 (COLREGS) is an International Maritime Organisation Convention and has been adopted worldwide as the rules of the road afloat.

All masters of a vessel must be aware of the COLREGS which are adopted in Victoria through the MSA and MSR.

It is the duty and responsibility of anyone in charge of a vessel to be able to correctly apply these rules in all circumstances including when at anchor.

Many collisions between vessels result from a lack of understanding of the rules of safe navigation, as well as carelessness. The information in this chapter is based on the requirements of COLREGS, MSA and MSR.

Everyone on the water has a legal and moral duty to maintain a proper lookout and travel at a safe speed at all times.

This duty includes handling a vessel and observing the rules, knowing the limitations of your vessel, being aware of potential hazards and allowing for the actions of others, both reasonable and unreasonable.

It pays to take care!

An operator can be deemed to be negligent if proper care was not taken subject to circumstances. 'Reckless' navigation occurs when someone handles a vessel in a way that causes an obvious or serious risk of physical injury to another using the same waters, or to property.

'Dangerous navigation' occurs when a vessel is propelled at speed or in a manner causing real or potential danger to any person or property and is a punishable offence. Any use of a vessel resulting in nuisance or causing obvious annoyance to any other person, deliberately or accidentally is also a punishable offence. The authorities and the courts take both recklessness and negligence most seriously.

Some of the COLREGS provisions that are relevant to recreational boaters are summarised below.

RULE 5 **KEEPING A PROPER LOOKOUT**

Every vessel shall at all times maintain a proper look-out by sight and hearing as well as by all available means appropriate in the prevailing circumstances and conditions so as to make a full appraisal of the situation and of the risk of collision.

Safe navigation of a vessel requires you to:

- observe the rules including handling of a vessel
- know the limitations of your vessel
- be aware of potential hazards
- allow for the actions of others, both reasonable and unreasonable.

RULE 6 **EVERY VESSEL SHALL PROCEED AT A SAFE SPEED**

Every vessel must travel at a safe speed at all times so that it can take proper and effective action to avoid a collision and be stopped within a distance appropriate to the prevailing circumstances and conditions. A speed at which the master of a vessel can take proper and effective action to avoid a collision depends on:

- visibility
- sea state and weather
- vessel characteristics
- traffic
- background/ambient lights
- proximity to hazards
- draught of the vessel and the depth of water
- reliability of radar image in the prevailing conditions.

RULE 7 **RISK OF COLLISION**

Every vessel shall use all available means appropriate to determine if a risk of collision exists. If there is any doubt, such risk shall be deemed to exist.

RULE 8 **ACTION TO AVOID A COLLISION**

The giving-way vessel shall:

- take early and positive avoiding action
- make course/speed alterations obvious to the other vessel
- avoid crossing ahead of the vessel with right of way
- stop or reverse if necessary.

A series of five or more short and rapid blasts on a whistle or horn should be used to indicate that insufficient action is being taken to avoid collision.

The vessel with the right of way shall keep its course and speed. It should take avoiding action only if that taken by the giving-way vessel is insufficient. If necessary it should take whatever action is available to keep clear and avoid a collision.

If a power-driven vessel is taking action to avoid a collision with another power-driven vessel it shall, if possible, avoid altering course to port. This action does not relieve the vessel operator of handling obligations.

RULE 9 **NARROW CHANNELS**

All vessels in narrow channels shall keep, as far as practicable, to the starboard side of the channel.

A vessel engaged in fishing shall not impede the passage of any other vessel navigating within a narrow channel or fairway.

A vessel shall not cross a narrow channel or fairway if such crossing impedes the passage of a vessel that can safely navigate only within such channel or fairway.

A sailing vessel and a vessel under 20 m in length shall not impede the passage of any vessel which can safely navigate only within a narrow channel or fairway.

Any vessel shall, if the circumstances of the case permit, avoid anchoring in a narrow channel.

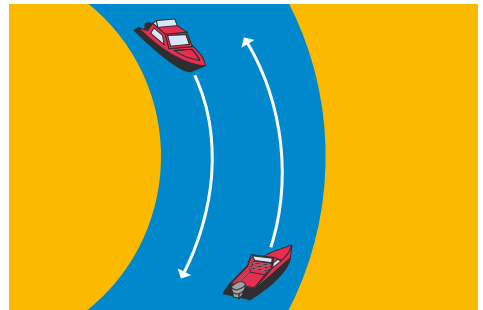

RULE 12 SAILING VESSELS APPROACHING ONE ANOTHER

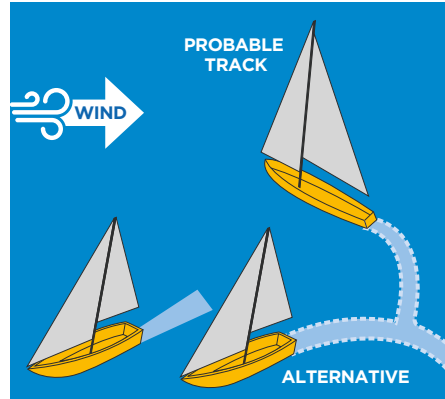
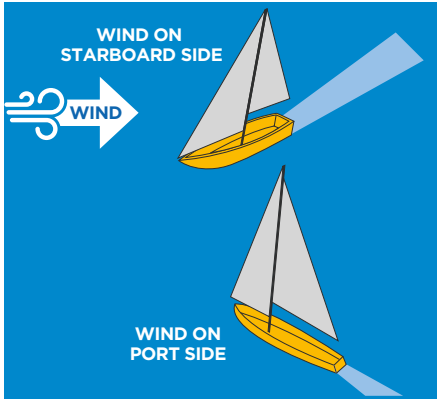

When each has the wind on a different side, the vessel which has the wind on the port side shall keep out of the way of the other.

When a sailing vessel with the wind on its port side sees another sailing vessel to windward and cannot determine with certainty whether that sailing vessel has the wind on its port or its starboard, it shall keep out of the way of that other sailing vessel.

When both have the wind on the same side, the vessel which is to windward shall keep out of the way of the vessel which is leeward.

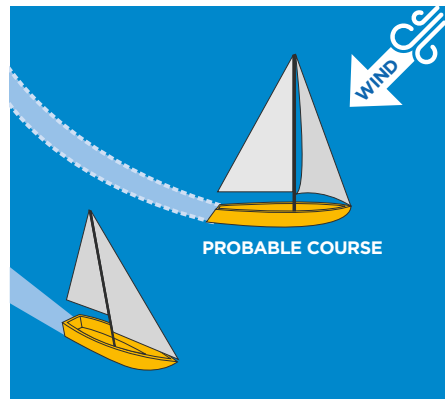
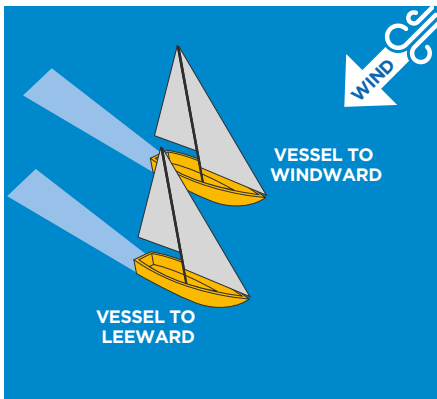

RULE 13 OVERTAKING

All vessels, whether sail or power, overtaking another vessel when the boats are in sight of one another shall keep out of the way of the vessel being overtaken. That is, if a vessel is coming up with

another from any direction which is more than 22.5 degrees (in the shaded arc of the diagram below) abaft her beam, it shall be deemed to be the overtaking vessel until finally past and clear.

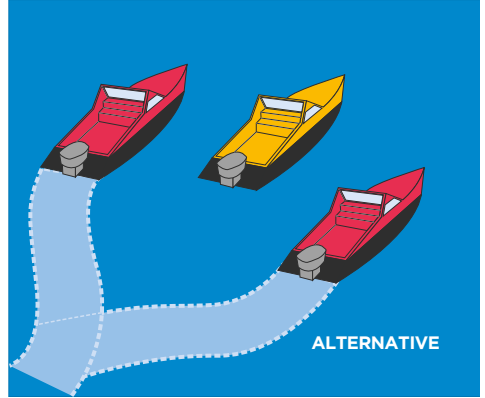
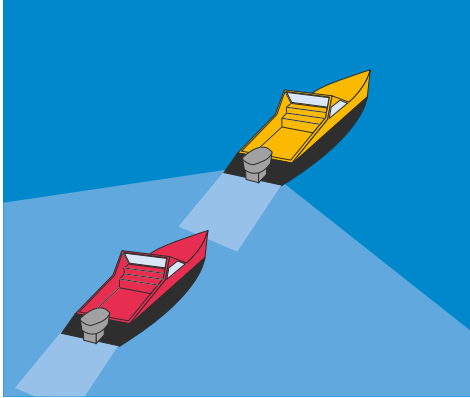

If in doubt, assume that you are the overtaking vessel and keep clear. Alteration of course by either vessel does not relieve the overtaking vessel of the responsibility of keeping clear.

RULE 14 HEAD ON SITUATION – EACH VESSEL TO STEER TO STARBOARD

Power-driven vessels meeting head-on or nearly head-on shall alter course to starboard so that each may pass on the port side of each other.

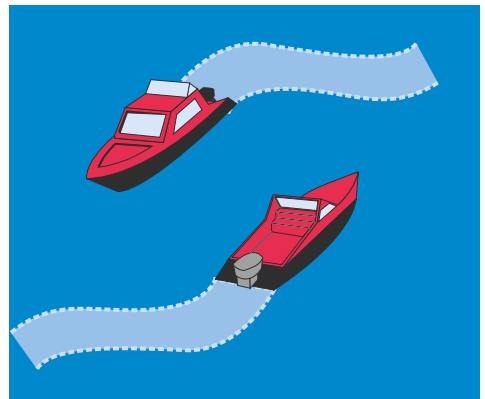
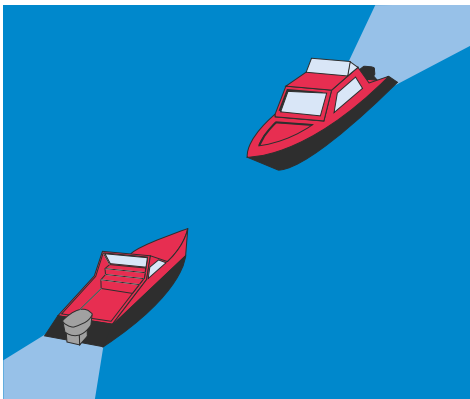

RULE 15 POWER DRIVEN VESSELS CROSSING SITUATION

When two power-driven vessels are crossing, the vessel with the other on its starboard side shall keep out of the way and avoid crossing ahead of the other vessel. The other vessel must

maintain its course and speed until it is apparent that the vessel required to give way is not taking appropriate action.

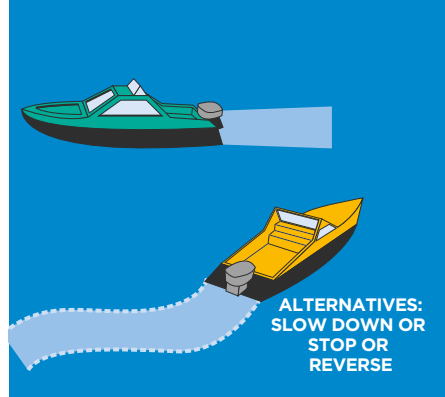
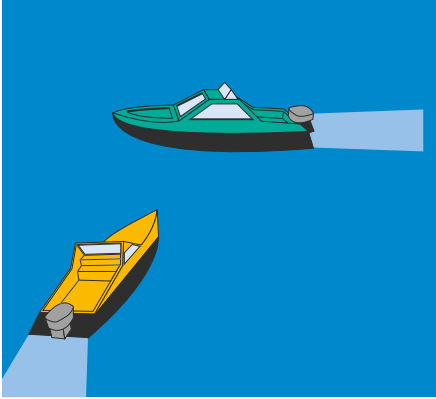

RULE 18 RESPONSIBILITIES BETWEEN VESSELS

Power and sail vessels

Power-driven vessels shall keep out of the way of sailing vessels.

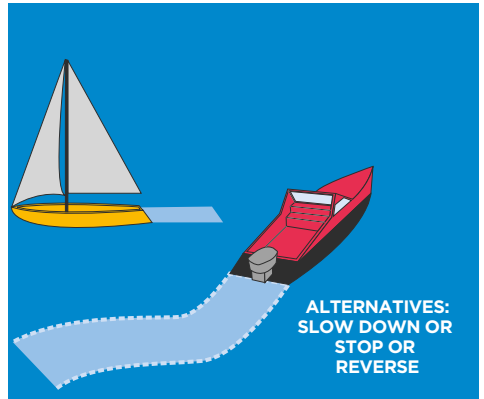
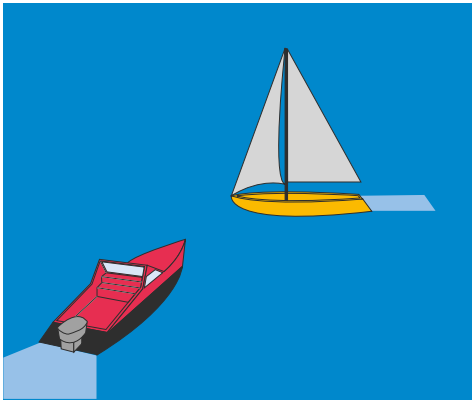

A vessel under power

The master of a power-driven vessel (the give-way vessel) underway must ensure that the vessel keeps out of the way of:

- (a) a vessel constrained by its draught that is displaying lights or shapes to indicate that it is constrained by its draught
- (b) a vessel not under command that is displaying lights or shapes to indicate that it is not under command
- (c) a vessel restricted in its ability to manoeuvre that is displaying lights or shapes to indicate that it is restricted in its ability to manoeuvre
- (d) a fishing vessel engaged in fishing with nets, lines, trawls or any other fishing apparatus which restricts its ability to manoeuvre
- (e) a sailing vessel.

A sailing vessel

The master of a sailing vessel (the give-way vessel) underway must ensure that the vessel keeps out of the way of (a) to (d) above.



Large vessels

Recreational vessels have a responsibility to stay well clear of large vessels. Small craft are prohibited from impeding the passage of big ships. All boat operators should take note of the following:

- big ships operate at all times of the day and night
- the speed of a ship can be deceptive and may be in excess of 20 knots
- ships can weigh up to 100,000 tonnes and do not have brakes
- ships cannot stop or change course suddenly and will travel a long distance before stopping
- a ship's blind spot can extend for many hundreds of metres ahead
- bow waves caused by a ship can swamp a small boat hundreds of metres away
- sailing vessels do not have right of way over big ships
- a ship may sound five short blasts on its whistle if it believes you are at risk of a collision. Small vessels must take evasive action immediately.

RULE 19 RESTRICTED VISIBILITY

In restricted visibility, reduce to minimum speed. When hearing the fog signal of another vessel ahead, proceed with extreme caution until danger of collision is over or stop until you have ascertained the danger.

BUOYAGE IALA SYSTEM A

The buoyage system used in Victorian ports and around the coast is known as the IALA System A, which is a system of different types of navigational markers. Although called a buoyage system,

markers may be buoys, piles or beacons. To navigate safely, you need to know each marker and its meaning as each has its own colour, shape, top mark and light combination.

IALA SYSTEM A LIGHT RHYTHM TYPES

Rhythm	Description	Navigation chart abbreviation
Fixed	A light showing steadily and continuously	F
Flash	Duration of light shorter than duration of darkness	FL
Occulting	Duration of light longer than duration of darkness	Oc
Iso phase	Duration of light and darkness are equal	Iso
Quick flash	A flash rate of 60 or 50 per minute	Q
Very quick flash	A flash rate of 120 or 100 per minute	VQ
Long flash	A flash of not less than two seconds	LFI
Group flash	A group of two or more flashes (with the number indicating the number of flashes in a group)	FL(2) or VQ(9)
Morse A	A light flashing Morse code signal A (dot, dash)	Mo (A)

Note:

When the light exhibited is not white, the colour is indicated in the chart abbreviation by Y (yellow), R (red) or G (green), for example, FL(4)Y
The period of a light (time between the start of successive sequences) is indicated in seconds by the letters, for example, FL.R.5s means a single red flash every five seconds.

DIRECTION OF BUOYAGE

In order to navigate safely it is essential to know the direction of buoyage.

On Victorian coastal waters, buoyage runs east to west through Bass Strait and from seaward inwards to ports, harbours, rivers, estuaries and other waterways. When leaving a port, harbour, river, estuary or other waterway the port-hand mark (red) should be passed on the vessel's starboard (right) side.

Upon entering a port, harbour, river, estuary or other waterway the port-hand mark (red) should be passed on the vessel's port (left) side.

As Western Port has two entrances, boundaries are laid down to indicate where the direction of buoyage from each entrance meets. They form a line from just north of Lang Lang River to Palmer Point (French Island) to Observation Point (Phillip Island).

It is necessary to know the direction of north and the other main points of the compass.

Under the MSA it is an offence for any person to interfere or tamper with, or obstruct the use or operation of, a navigation aid.

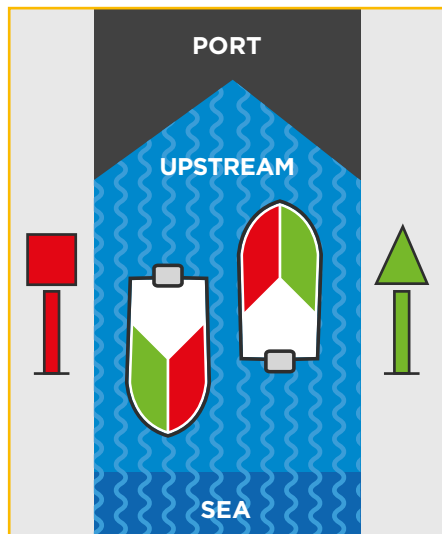

BUOYAGE TYPES

There are five major types of marks under the IALA System A: lateral, cardinal, isolated danger, special and safe water.

LATERAL MARKS



These are used to indicate the port (left) and the starboard (right) sides of the channels when travelling into port.

Port-hand marks are red and the basic shape of the buoy (and topmark when fitted) is cylindrical (a can). Such a mark would be on the port side of a vessel when travelling in the direction of buoyage.

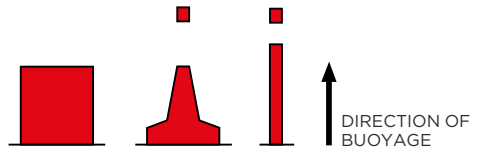
- Colour:** Red
- Shape (buoys):** Cylindrical (can), pillar or spar
- Topmark (if any):** Single red cylinder (can)



Lights are red (when fitted) and may have any rhythm other than composite group-flashing (2+1). They are used on modified lateral marks to indicate a preferred channel. Examples are:

- Q.R** Continuous Quick Light 
- Fl.R** Single-Flashing Light 
- L Fl.R** Long-Flashing Light 
- Fl (2) R** Group-Flashing Light 



Starboard-hand marks are green (occasionally, black may be used) and the basic shape of the buoy (and topmark when fitted) is conical. This mark would be on the starboard side of a vessel when travelling in the direction of buoyage.

- Colour:** Green
- Shape (buoys):** Conical (cone), pillar or spar
- Topmark (if any):** Single green cone point upwards

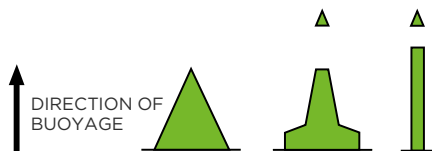

Lights are green (when fitted) and may have any rhythm other than composite group-flashing (2 +1). They are used on modified lateral marks to indicate a preferred channel. Examples are:

- Q.G** Continuous quick light 
- FI.G** single-flashing light 
- L.FI.G** long-flashing light 
- FI (2) G** group-flashing light 

When marks are numbered, odd numbers are on the starboard side and even numbers on the port side when travelling in the direction of buoyage. They are numbered from seaward to port.



CARDINAL MARKS

These are used to indicate the location of the best navigable water, to show the safe side on which to pass danger (rocks, wrecks, shoals, etc.) and to draw attention to a feature in a channel.

To understand the meaning of a particular cardinal mark, the navigator must be aware of geographical directions and therefore needs a compass to determine where the best navigable water lies. The mark is placed in one of the four quadrants: north south, east or west. If in doubt, consult the chart.

Shape

The shape of a cardinal mark is not significant, but in the case of a buoy it will be a pillar or spar.

Topmark

The most important daylight feature of the cardinal mark is the black double cone top mark and the four different arrangements that indicate the relevant direction from the mark.

Colour

Black and yellow horizontal bands are used to colour the cardinal marks and indicate the type of cardinal mark. Top mark cones point in the same direction as the location of the black bands on the marks.

Lights

If lit, the mark will exhibit a quick flashing (about 1 per second) or very quick flashing (about 2 per second) white light. The rhythm of the light will indicate the particular quadrant of the mark.

The number of flashes corresponds to the numbers on a clock face:

N = continuous flash

E = 3 flashes

S = 6 flashes

W = 9 flashes.



West cardinal mark

Topmark consists of two cones point to point. The mark has yellow/black/yellow bands. When lit, a west mark exhibits a white light flashing in groups of nine quick or very quick flashes.

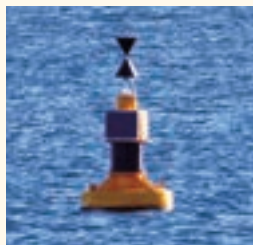

Pass on the western side of this mark.

North cardinal mark

Topmark consists of two cones pointing up. The mark has a black band over a yellow band. When lit, a north mark exhibits a continuous quick or very quick flashing white light. Pass on the northern side of this mark.



Pass on the northern side of this mark.

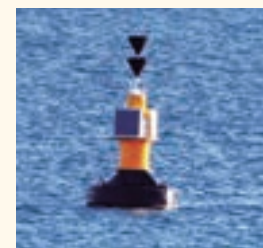
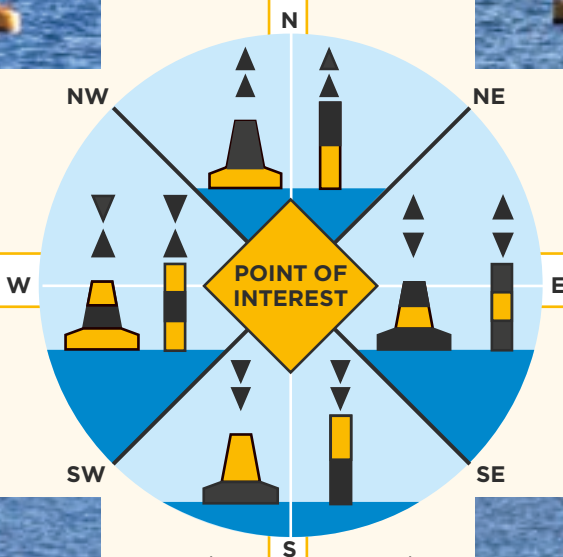

Topmark consists of two cones pointing down. The mark has a yellow band over a black band.

When lit, a south mark exhibits a white light flashing in groups of six quick or very quick flashes followed by a long flash. Pass on the southern side of this mark.

South cardinal mark

Topmark consists of two cones pointing away from each other. The mark has black/yellow/black bands. When lit, an east mark exhibits a white light flashing in groups of three quick or very quick flashes. Pass on the eastern side of this mark.

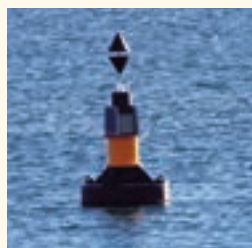

East cardinal mark

SPECIAL MARKS

These are used to indicate a special area or feature, the nature of which may be found by consulting a chart or sailing directions. Some local examples are the spoil ground, pipeline and recreation buoys in Port Phillip and the pilot buoy off Flinders in Western Port.

The colour of the special mark is always yellow, and the top mark, if fitted, is a single yellow X. Some special marks may be in the shape of a lateral mark. If a light is fitted it will be yellow and may have any rhythm not used for white lights, for example, FLY, FI.(4) Y.

In Victorian waters, special marks are commonly used to indicate no boating zones, special activity zones and speed restriction zones.

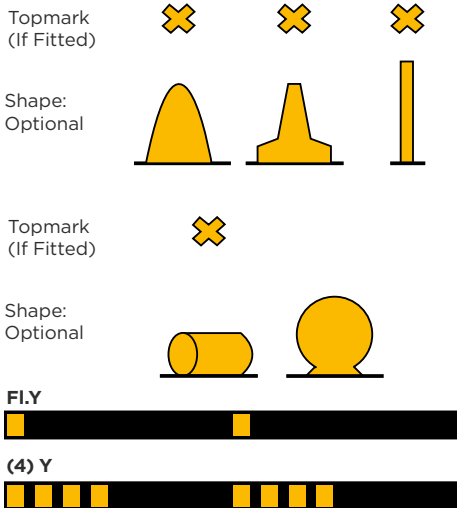

ISOLATED DANGER MARKS

These are on, or moored above, an isolated danger of limited extent that has navigable water all around it. The colours are red and black horizontal stripes and the mark is, when practicable, fitted with a topmark of two black spheres, one above the other. If lit, the light will be white showing a group of two flashes. It may help to remember this mark by associating the two flashes with two spheres.

Some examples of the isolated danger mark are on the Prince George Bank off Indented Head, Wooley's Reef at Frankston and Eagle Rock in northern Western Port. Isolated danger marks are not always positioned centrally over a danger and it is therefore advisable to refer to a chart and not to pass too close.

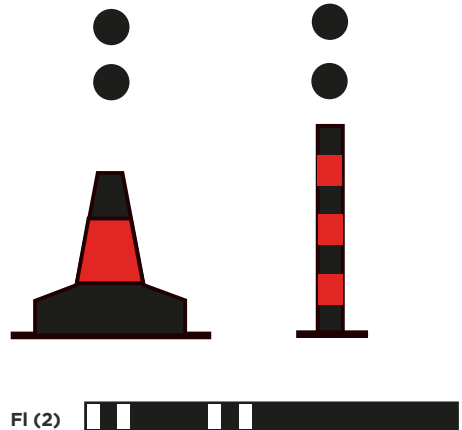

SAFE WATER MARKS

These are used to indicate that there is navigable water all around the mark. These marks can be used as a channel entrance, centre line, mid-channel, or landfall buoy. The Westernport Fairway buoy is a local example of this mark. The shape of the buoy can be a sphere, spar or pillar and is coloured with red and white vertical stripes. The topmark, which is fitted, when practicable, to pillar and spar buoys, is a single red sphere. If lit, an isophase, occulting, one long flash every ten seconds, or morse 'A' (dot, dash) white light is exhibited. The buoy shape is optional but should not conflict with that used for a lateral or special mark.

Operators of vessels are cautioned that large commercial vessels may pass close by these marks.

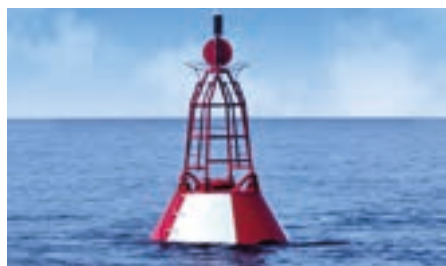
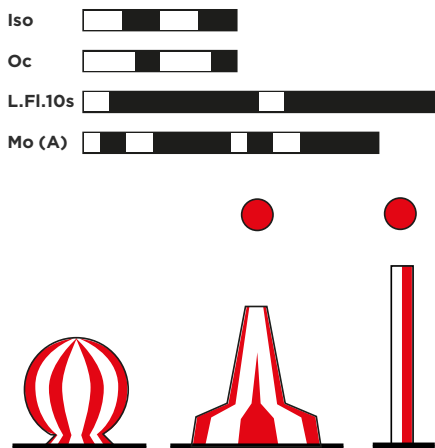

NEW DANGER MARK

The term new dangers is used to describe newly discovered hazards not yet shown in nautical documents. New dangers include naturally occurring obstructions such as sandbanks or rocks or man-made dangers such as wrecks. New dangers may be marked using lateral, cardinal, isolated danger marks or by using the emergency wreck marking buoy. The mark may be removed when the new danger has been sufficiently communicated or otherwise resolved. The shape of the emergency wreck marking buoy is a pillar or spar and is coloured with blue and yellow vertical stripes. The topmark, if any, is a vertical/perpendicular yellow cross. The light will occult to show alternate blue and yellow light; one second of blue light and one second of yellow light with half a second of darkness between.

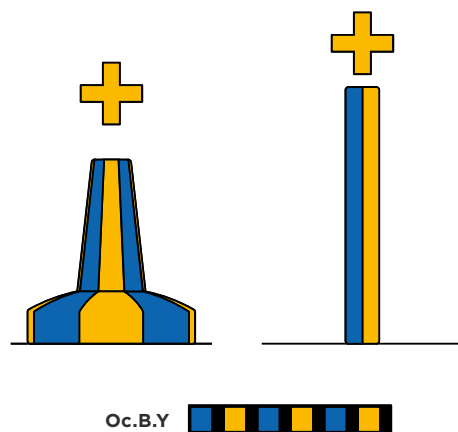

BOATING ZONE BUOYAGE (INLAND WATERWAYS)

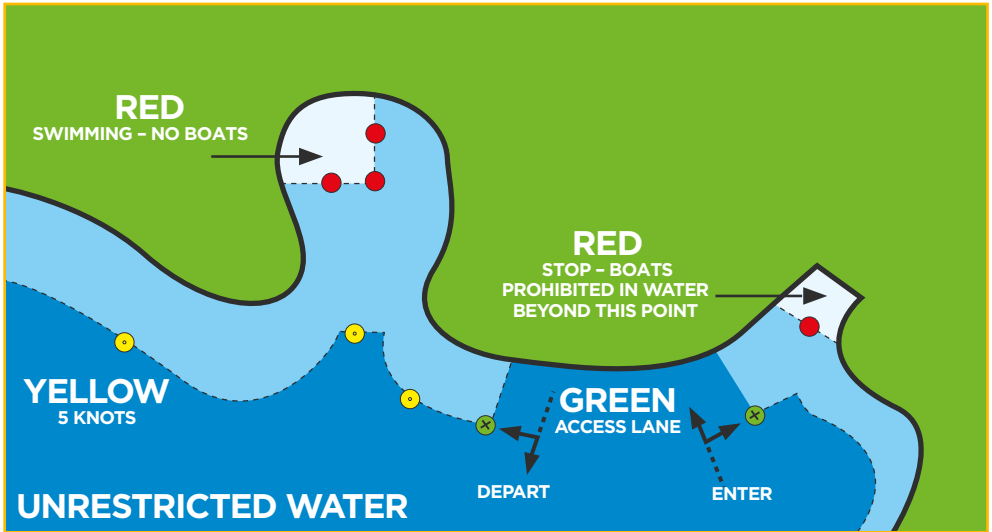

RED MINI BUOY

'Stop - no boats' or 'Swimming - no boats': used to mark prohibited water and swimming areas.

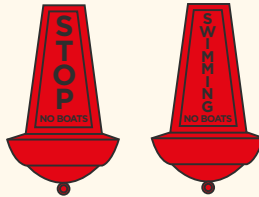

GREEN MINI BUOY

Access lane: the waters between these buoys are unrestricted to allow the picking up or dropping off of a water skier.



YELLOW MINI BUOY

Speed restrictions: an area is set aside as a speed restriction zone because excessive speed is a risk to the operator, to other vessels or persons, or to the environment. The yellow buoys may be placed because of local or general requirements for slower speeds.



RED AND YELLOW MINI BUOY

Special purpose: these unmarked buoys are used to signify things like regatta areas, hazards, channels.

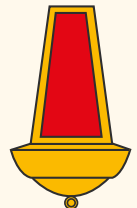

BOATING ZONE MARKS AND SIGNAGE

Sometimes signs on the shore are used instead of, or in addition to, marks in the water. Examples of boating signs include “No boating zone”, “special purpose zone” or prohibited zone”.

Access lanes are solely for waterskiing or for launching or retrieving a vessel at a boat ramp when the ramp is located in that area. Access lanes are marked by beacons or signs on the shore with each boundary being delineated by the alignment of an orange disc and a black and yellow triangle beacon. Access lanes provide access to the shore for waterskiers at speeds greater than 5 knots when otherwise it might not be possible. Bathers are not permitted within an access lane.

Special purpose areas such as waterskiing only, PWC or kite boarding areas may also use onshore beacons to delineate the zone. In this case an orange disc may be used with a black and white triangle.

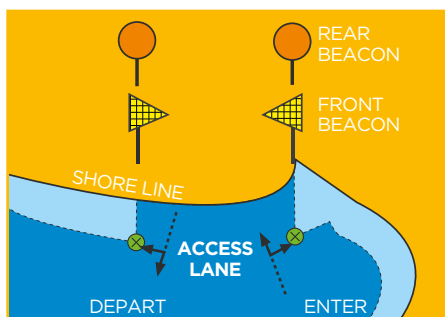

NAVIGATION LIGHTS

The MSA and MSR require that lights are displayed from sunset to sunrise and in times of restricted visibility during daylight hours. Vessel navigation light layout and sectors are shown in the image below:

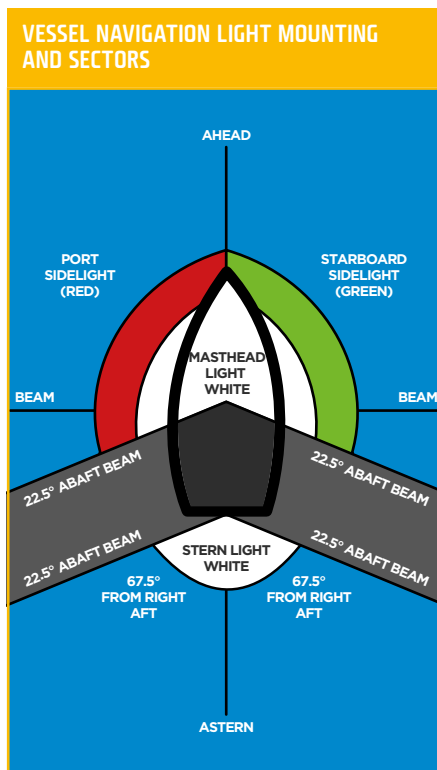

OPERATING AT NIGHT

Navigating at night or at times of restricted visibility can be hazardous. It is more difficult to judge speeds and distances than during a clear day so you must take every precaution. Vessels under way must show the proper lights from sunset to sunrise and in restricted visibility. You must also be able to tell from the lights of other vessels what they are, what they are doing and their direction of travel, so you can take the right timely action to avoid collision.



Occupants of vessels less than 12 m in length are required to wear lifejackets at all times when the vessel is under way and they are in an open area of the vessel when operating at night.

You must familiarise yourself with navigation hazards, lit and unlit, fixed or whose position may occasionally change.

Know where they are, from unlit buoys to rocks and shoals, and keep their position in relation to your vessel constantly in mind. Spotlights and lightbars may be used, but take care not to dazzle other people on the water, or yourself.

Only specified navigation lights should be shown at night. Any other lights onboard must not interfere with the range and arc of visibility of navigation lights or the ability of others to maintain a proper lookout

Always travel at a reduced speed to increase your safety margin. Keep a careful lookout around you for hazards and other vessels and, for extra reassurance, travel in company with another vessel or vessels where possible.

A proper lookout is important when the background of bright lights on shore tends to obscure the lights of other vessels, buoys and marks. This is especially true in waters close to populated areas, such as the shore of Port Phillip where even larger ships can be hard to see.



VESSEL NAVIGATION LIGHTS TO BE DISPLAYED

Recreational vessels at anchor

All recreational vessels must show an all-around white light while at anchor. However, if the vessel is drifting (under way but not making way) the vessel must display appropriate navigation lights.

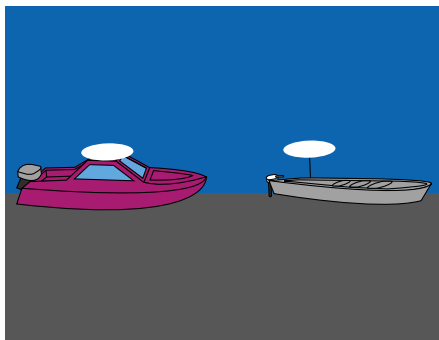

Sail and human powered vessels

Sailing vessels under way or drifting

A sailing vessel under way must exhibit side lights and a stern light. If the vessel is less than 20 m in length, the sidelights and stern light may be combined in one lantern (tricolour lantern) carried at or near the top of the mast where it can be seen.

In addition to the sidelights and stern light, a sailing vessel may exhibit at or near the top of the mast, where they can be best seen, two all-round lights in a vertical line, the upper being red and the lower being green. These lights must not be exhibited in conjunction with a combined lantern (tricolour lantern).

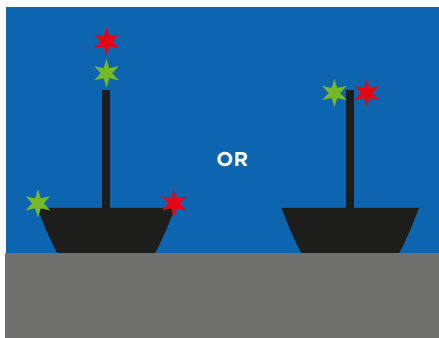
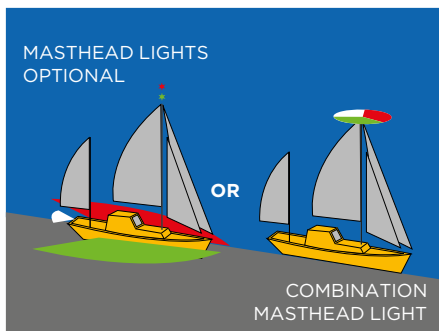

Reminder - whenever a sailing vessel is using its engine, with or without sails, it is a power-driven vessel within the meaning of the rules, and must act accordingly and show the appropriate shapes by day and lights by night. This means that a tricolour lantern or two red/green masthead lights must not be used under power.

*Sailing vessels under way
(not using power)*

Sailing vessels less than 7 m in length and boats under oars or drifting must, if practicable, display any of the combinations for vessels under sail.

An electric torch or lighted lantern showing a white light and exhibited in sufficient time to prevent collision is an acceptable alternative for these vessels when the lighting configuration described above is not practicable.

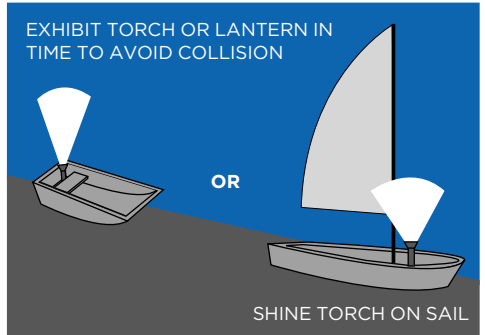
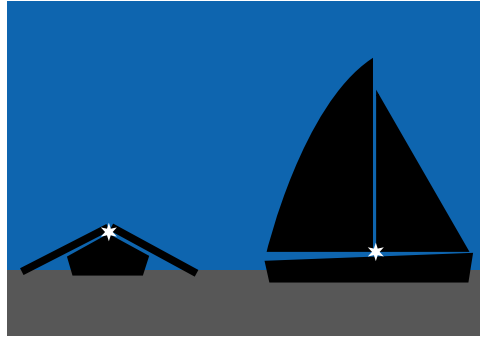

Powerboats

Powerboats under way or drifting

Vessels under 12 m in length must show:

- a) sidelights and an all round white light
- or**
- b) sidelights, masthead light and a stern light.

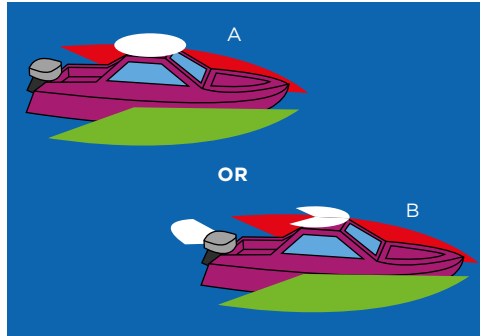

Vessels under 7 m in length and under 7 knots

Power-driven vessels of less than 7 m in length, whose maximum speed does not exceed 7 knots, when under way, may exhibit an all-round white light and must also, if practicable, exhibit sidelights.

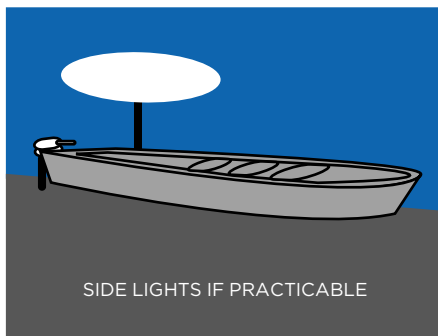

Larger vessels

Vessels under 50 m in length may exhibit a second masthead light.

Vessels under 12 m in length, sidelights may be combined in one lantern on fore and aft centreline.

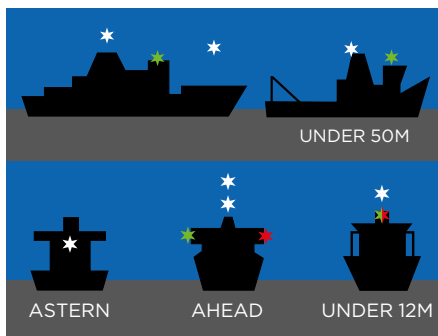

Vessels towing

A vessel towing another when the tow length is under 200 m must show two masthead lights (three masthead lights if over 200 m). A yellow towing light is situated over the stern light of the towing vessel. The towed vessel shows side and stern lights.



Vessels at anchor

Vessels 50 m or more in length must show two all-round lights, the forward one higher than the aft one. Vessels under 50 m may show a second (lower) light at stern.

A vessel of 100 m or more length shall also illuminate her decks with lights.

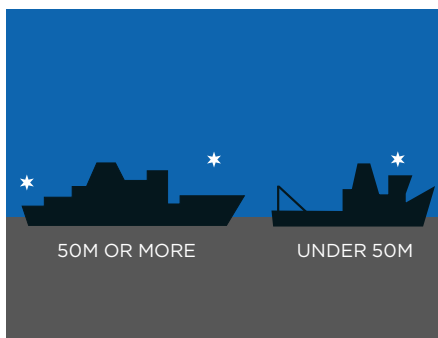

Vessels aground

A vessel aground must show anchor lights and two all-round red lights. A vessel under 12 m length is not required to exhibit these lights.

This signal does not mean distress or in need of help, but operators should navigate with caution.



Vessels restricted in ability to manoeuvre

A vessel restricted in its ability to manoeuvre, including diving vessels, must show three all-round lights, with the top and bottom lights being red and the middle light white. When making way through the water, the vessel must also show masthead lights, sidelights and stern light.

When at anchor, the vessel must also show anchor lights. This signal does not indicate distress or a need for help, but operators should navigate with caution.

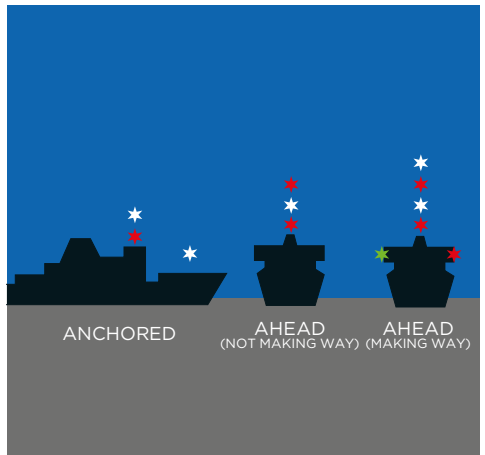

Vessels engaged in underwater operations

A vessel engaged in underwater operations, including dredging, with an obstruction on one side shall show lights indicating a restricted ability to manoeuvre. It must also show two all-round red lights on the side of the obstruction and two all-round green lights on the side that vessels may pass.

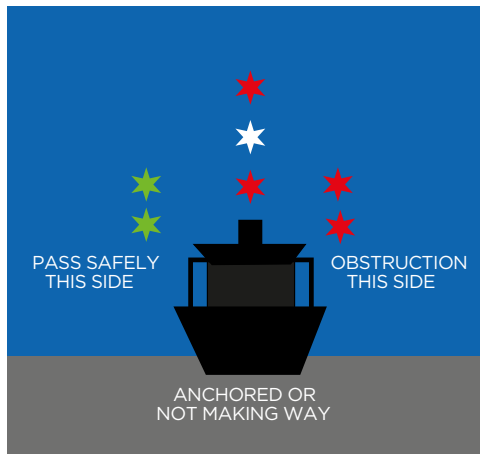

Vessels constrained by their draught

A power-driven vessel restricted to a narrow channel by her draught and unable to deviate from course must show lights for power-driven vessel under way and may also show three all-round red lights.

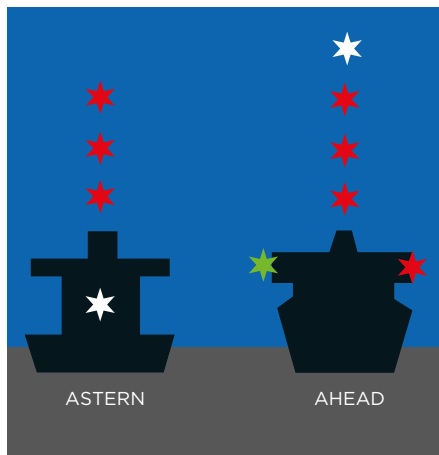

Pilot vessels on duty

Pilot vessels on duty must show two all-round lights, the top light white and the lower light red.

When at anchor, the vessel shows anchor light or lights and when under way sidelights and stern light.

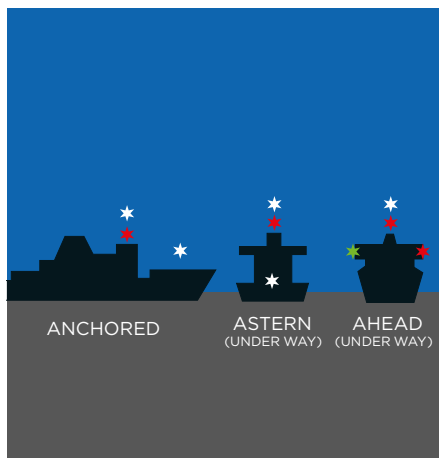

Vessels not under command

Vessels not under command must show two all-round red lights. When making way through the water, sidelights and stern light are also required. Vessels under 12 m in length, except those engaging in diving operations, are not required to comply with these lights. This signal does not mean distress, but shows inability to manoeuvre. Vessels are required to keep clear of vessels not under command.

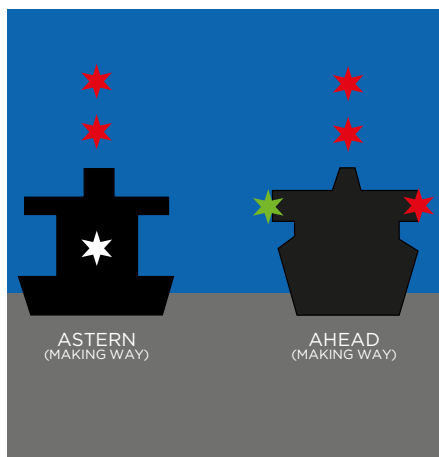

COMMERCIAL FISHING VESSELS

A commercial fishing vessel engaged in trawling must show two all-round lights, the top light green and the lower light white and a masthead light.

A rear masthead light is optional for fishing vessels under 50 m in length. When making way through water, sidelights and stern lights must also be shown.

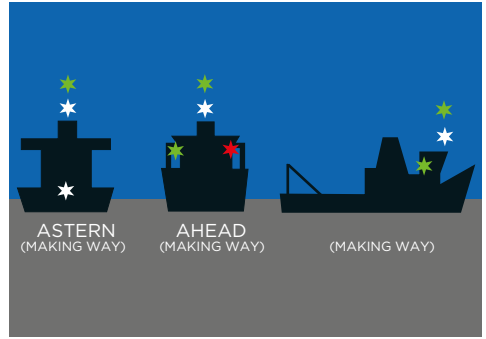

FISHING VESSELS (OTHER THAN TRAWLING)

A fishing vessel that is not trawling must show two all-round lights, the top light red and the lower light white. If outlying gear extends more than 150 m horizontally from fishing vessel, it must show one all-round white light in direction of gear plus sidelights and stern light shown when making way through water.

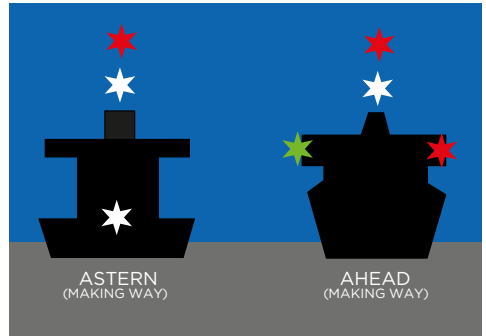

VESSELS WORKING IN CHAINS

A vessel working in chains, for example, Raymond Island Ferry, must show an all-round red light at each end. An all-round green light above the red light at the forward end must be used to indicate the direction in which the vessel is proceeding.



Vessels operating in the vicinity of the Paynesville/Raymond Island vehicular ferry must proceed with caution and keep clear of the ferry.

More information at transportsafety.vic.gov.au/msv/nav-lights



DAY SHAPES FOR VESSELS

Day shapes are signals shown by day in all weathers on vessels to denote certain activities in which vessels are engaged.

In restricted visibility, the appropriate lights should also be displayed by day. You must be able to recognize these day shapes which are generally used by larger vessels.

VESSEL AT ANCHOR

When at anchor, vessels greater than 7 m must display forward, where best seen, one black ball. This is not required for vessels of less than 7 m when at anchor, not in or near a narrow, fairway or anchorage, or where others normally navigate.



VESSELS UNDER POWER WITH SAILS SET

A vessel proceeding under power with sails set, that is motor sailing, must display forward, where best seen, one black cone, point down.



FISHING VESSELS

A fishing vessel using trawls, nets or other gear, whether under way or at anchor must display in a vertical line, two black cones pointing toward each other.



VESSELS NOT UNDER COMMAND

No day shapes are required for vessels under 12 m, except those engaged in diving operations.

Vessels greater than 12 m, must display two black balls in a vertical line where they are best seen. This indicates inability to manoeuvre not distress.



VESSELS CONSTRAINED BY THEIR DRAUGHT

A power-driven vessel restricted to a narrow channel by her draught and thus unable to deviate from her course must display one cylinder where it is best seen.



VESSELS AGROUND

A vessel greater than 12 m aground must display three black balls in a vertical line where they are best seen. This signal does not indicate distress or a need for help and is not required for vessels under 12 m length.



VESSELS RESTRICTED IN ABILITY TO MANOEUVRE

A vessel restricted in its ability to manoeuvre, for example, one engaged in flying aircraft, laying cable laying, replenishment at sea, underwater operations, servicing navigation marks, towing, where manoeuvre is restricted by tow, must display a black ball, black diamond, black ball in a vertical line where best seen. This signal does not indicate distress or a need for help.

When at anchor, the vessel must also show the shape required at anchor.



VESSELS ENGAGED IN UNDERWATER OPERATIONS OR DREDGING

A vessel with an obstruction on one side because they are engaged in underwater operations or dredging shall display two black balls on the side of the obstruction, and two black diamonds on the side on which vessels may pass. The ball, diamond, ball shape that indicates a vessel is restricted in its ability to manoeuvre must also be shown.

Black balls on both sides may be used to indicate passage or channel is blocked and vessels should await instructions before proceeding.

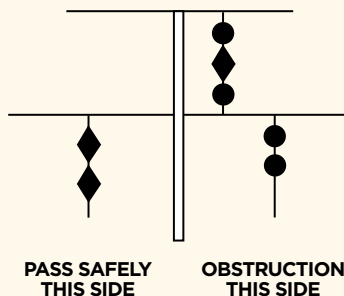

POWER-DRIVEN VESSELS TOWING

A power-driven vessel towing another when the length of tow is greater than 200 m must show one black diamond where best seen. The same shape must also be displayed on the towed vessel.

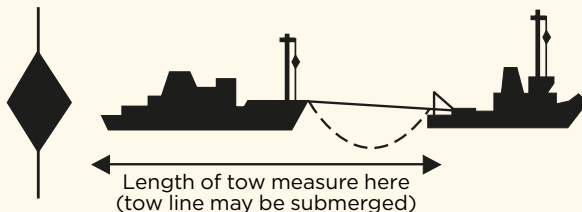

DIVING OPERATIONS

Any vessel with divers operating from it must always display signals by day or night to inform other vessel users.

The daytime signal for divers is an international Code Flag 'A', at least 750 mm long and 600 mm wide, in the case of a vessel that is less than 10 m. For vessels longer than 10 m, the dive flag must be at least 1 m. It should be placed to ensure all-round visibility.

During night diving, the vessel must show the international signal for a vessel restricted in its ability to manoeuvre. These must be at least three lights in a vertical line, with the top and bottom being red and the middle one white, only where the size of the vessel makes it impracticable to exhibit the lights and shapes otherwise required.

For Masters

Be aware that divers in the water may not be near a vessel. A diver who is not operating from a vessel that is displaying a dive flag will be attached to a buoy that has a dive flag attached to a rigid replica of the flag. A master of the vessel must not operate at a speed exceeding 5 knots within 100 m of a vessel or a buoy on which a dive flag is displayed. Divers may ascend at any time.

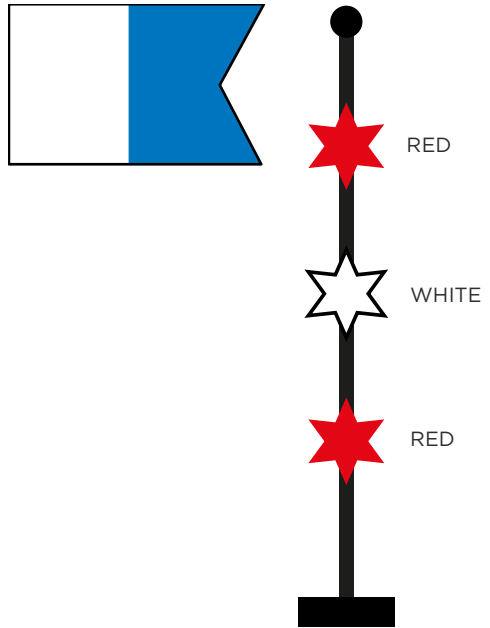





A master of a vessel must not cause or allow the vessel to be operated at a speed exceeding 5 knots within 100 meters of a vessel or buoy on which a dive flag is displayed, or a rigid replica of that dive flag.







SOUND AND LIGHT SIGNALS

DEFINITIONS AND CLASSIFICATIONS

Whistle	Means of making short or long blasts	
Short blast	About one second duration	
Prolonged blast	4–6 seconds duration	
Vessels of 100 m or more in length	Use bell, whistle and gong	
Vessels of 20 m or more in length	Use bell and whistle	
Vessels of 12 m or more in length	Use whistle	
Vessels less than 12 m in length	Use any efficient sound signal	



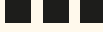



Manoeuvring and warning signals when vessels are in sight of one another

Whistle signals below may be supplemented by light signals using the same code.









DESCRIPTION	SIGNAL
I am altering my course to starboard	
I am altering my course to port	
I am operating astern propulsion	
I am unsure of your intentions, or doubt whether you are taking enough action to avoid collision	

Warning signals - vessels in narrow channels

When the vessel overtaking or being overtaken must take action to permit safe passing.

DESCRIPTION	SIGNAL
I intend to overtake on your starboard	
I intend to overtake on your port	
Agreement by overtaken vessel	
A vessel in doubt about signals, intentions or safety of the proposed manoeuvre of an overtaking vessel	
Vessel nearing blind bend in channel	
Vessel other side of bend repeats	

SOUND SIGNALS FOR VESSELS IN RESTRICTED VISIBILITY (DAY AND NIGHT)

DESCRIPTION	MAX PERIOD	SIGNAL
Power under way and making way	every two minutes	
Power under way and not making way through water	every two minutes	
<ul style="list-style-type: none"> • Not under command • Restricted manoeuvring • Constrained by her draught • Sailing ship - not under power • Vessel fishing • Vessel towing or pushing 	every two minutes	
Vessel towed - if manned	every two minutes	
Pilot vessel on duty- gives normal signals above and may sound four short blasts		
Vessel at anchor (under 100 m in length) BELL rung for five seconds	every minute	
Vessel at anchor (100 m or more in length) BELL rung for five seconds from the bow of the vessel and then - GONG rung five seconds from the aft of the vessel immediately following bell signal	every minute	
Vessel at anchor - may give WARNING of possibility of collision to approaching vessel		
Vessel aground - as at anchor but preceded and followed by three separate and distinct BELL strokes		
Vessels under 12 m in length may make the appropriate signals given above but, if not, must make some other efficient sound signal every two minutes		

BASIC BOAT HANDLING TIPS

LAUNCHING

Launching a boat from a trailer and retrieving it (loading) are important skills. In each instance, they must be carefully planned and executed to ensure safety and to avoid damage to the vessel.

- Make pre-launch preparations well away from the ramp.
- Include checking the bungs in your pre-launch preparations.
- If you're launching a trailer sailer, check for overhead wires before you rig or move your boat.
- Line up the car and trailer so that the backing process will be straight and as short as possible.
- Study the ramp and surrounding water area for any hazards.
- Do not remove the trailer winch or safety chain until your vessel is in the water.
- Secure lines to the bow and stern, then either float or motor off with care.
- When setting off, insist that everyone on board is within the boat itself, not on the side decking and especially not on the bow or where they will obstruct your view.
- Move off slowly.
- Always check for trailing ropes that could get caught in your propeller.



BERTHING AND UNBERTHING

This section provides some tips (courtesy of Club Marine), about manoeuvring alongside jetties and other boats.



**Know your boat!
Know how it handles and what
impact waves, wind and current
would have on handling it.**

- Understand how your boat reacts when left to drift in a breeze. Knowing how the boat will swing, or want to swing at low speed is really important knowledge to have when manoeuvring in confined spaces in windy conditions.
- Boats steer from the stern, which means that the stern swings out when steering. In most conditions you cannot drive a boat forward off a jetty. Doing this will typically result in the stern colliding with the jetty, or other boats, as it swings away from the direction of the turn.
- If you find yourself in trouble and drifting toward other boats or structures, reverse. The stern is where the steering is, so use the throttle to pull the boat backwards and out of harm's way.
- Skippers need to become familiar with how their boat reacts to the throttle and gears. Common problems are not being in or out of gear at the right time, or using more power than is needed.
- In outboard or sterndrive boats it's common for people to coast in neutral and expect the boat to steer. In these boats, it's the position of the leg and thrust that steers the boat.
- Rudders require flow of water to provide turning forces.
- Slipping in and out of gear is a good technique to practise.
- Turning the wheel and constant adjustment of speed through engagement and disengagement play an important part in controlling the boat. Getting it wrong can result in a nasty crunch!
- Boats will slide when turning. How much will depend on the hull shape, boat weight, speed and environmental conditions. This can cause problems in confined areas and should be taken into account.
- Sliding sideways can actually be helpful when berthing alongside a jetty. The slide, when executed correctly can put a vessel alongside nicely.
- Slow down and only use sufficient power to counteract wind and/or tidal flows.
- Train your crew to throw a line or loop over a cleat or bollard when coming alongside, rather than jumping off a moving vessel to secure lines. Always make safety for you and those around you paramount.
- Have crew positioned before coming alongside as any movements to get into position or grab a line or fender can upset the trim and alter the boat's path through the water, and affect your final approach.
- Develop the right skills and be confident in boat handling. Practice your skills in an area where there is a lot of space and minimal traffic. You can gradually practise in tighter spaces as you gain more confidence.

For more information visit
www.clubmarine.com.au

ANCHORING

Anchoring is not only a normal part of boating, it is also an important safety measure in an emergency. Anchoring may keep the vessel safely positioned head on to heavy conditions and it can also allow you to retain your position and not be swept away or on shore.

The anchor with chain or line, or both, must be of sufficient strength and durability to secure the vessel. It must also be appropriate for the area of operation of the vessel. The chain or line or combination must be securely attached to both the anchor and the vessel at all times.

- Choose your anchor, chain/or line carefully to suit your vessel requirements, the depth of water, and the bottom type you are likely to find where you are operating.
- Always lower the anchor rather than hurling the anchor and chain overboard as this may lead to tangling.
- As a rule of thumb, the line paid out should be at least three times the depth of water. This distance should be increased to five to one in rougher seas.

- Regularly check the anchor is not dragging by inspecting the rope tension and monitoring your position.
- Never drop anchor from the stern or midship, you risk swamping the vessel.



The use of a sliding buoy system in anchor recovery is not recommended. If the anchor fouls, large forces may be transferred to the vessel leading to capsize or damage to the vessel.

Vessel Operating and Zoning Rules (VOZR), see Regulatory Environment section, states that anchorage of vessels is not permitted in certain areas.

- It is illegal and dangerous to anchor in shipping channels or transit lanes.
- It is illegal and dangerous to tie vessels to navigational aids.

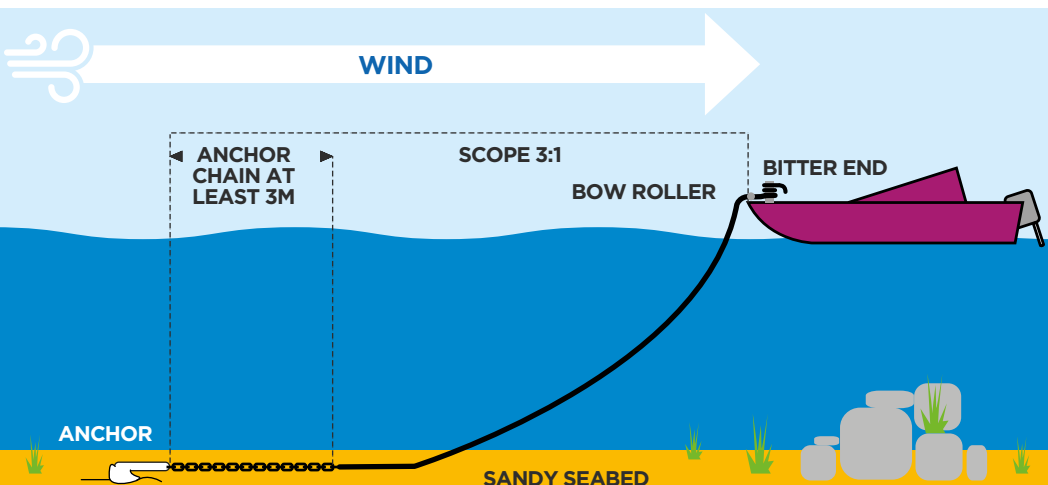

MOORING

If you intend to put down a permanent mooring, contact your local waterway manager. The following issues should be considered:

- is the location protected from wind and tide effects
- can it be easily accessed for use and regular maintenance
- will it interfere with any other mooring or property
- will your vessel have full swing clearance?

It is recommended that a professional install the mooring for you once you receive approvals from the relevant authority. Check the condition of lines and attachment points on your vessel for damage and wear regularly.

When you are 'picking up' (attaching to) a mooring:

- travel slowly
- observe wind and/or tidal flow before approaching a mooring
- don't take other boats' positions as a guarantee of wind and current; some boats lie in the opposite direction to the wind and/or current, as surface effects of wind may differ from general tidal or current effects
- use the small pick-up buoy as an indicator of drift direction
- approach slowly into the wind or against the tide, using the stronger of the two as a 'brake'
- don't overrun the mooring buoy as this risks fouling the propeller on mooring lines
- use a boat hook to capture the pick-up buoy
- secure the line or chain to a bow cleat.

When you are leaving a mooring:

- warm up the engine – or prepare the sails if sailing
- check for other boats nearby
- travel slowly, and make sure your passengers and crew stay within the boat itself—not on the side decking or the bow, where they could block your view or risk injuring themselves
- relieve any heavy strain on the mooring by using the motor or sails to come up to it
- release the chain or rope from the bow cleat, and drift back to clear the buoy before moving away. As you drift, check for trailing ropes that may get caught in your propeller.

RETRIEVING

This is an important skill that should be practised at a quiet ramp. The key points are:

- align the centre of your vessel to that of the trailer; proceed carefully up the trailer until the winch or safety chain can be secured
- secure a line to both the bow and stern to control the boat as you use the winch. If you are not confident about driving your vessel on to the trailer
- vacate the ramp as quickly as possible and park in the appropriate preparation area to finish securing the vessel for towing.

More information at [transportsafety.vic.gov.au/msv/safe-operation](https://www.transportsafety.vic.gov.au/msv/safe-operation)



Secure your vessel to the trailer using both the winch and safety chain.



TOWED WATER SPORTS

Towed water sports such as waterskiing, wakeboarding, tubing and kneeboarding are popular recreational boating activities and often involve high speeds. A recent Monash University study commissioned by Transport Safety Victoria (TSV), examined data from 2005 to 2015 that produced some interesting insights.

- maritime-related injuries occur most frequently to males aged 15-29 residing in metropolitan Melbourne .
- males outnumbered females 4:1 and this finding is consistent with figures previously reported by TSV (2016)
- injuries were more common in the 17-29 year age group but those aged 30-44 and 45-59 years still accounted for a comparable proportion of maritime-related injuries
- waterskiing, wake boarding and knee boarding were identified as a cause of injury in 37% of maritime incidents resulting in emergency department presentations.

Where death, injury or property damage occurs, the incident details should be reported as soon as possible to the police officers present or to the police station nearest to where the accident took place.

Vessel masters and crew members should arm themselves with appropriate skills and be aware of the local waterway rules.

OBSERVER

The obligation is on the master of a vessel not to tow without an observer on board.

The observer must be at least 12 years of age. In NSW Waters, including the Murray River, observers must hold a boat or PWC driving licence or be 16 years of age or older.

The observer must watch the water skier at all times and give the master directions to keep the water skier safe. This allows the master to concentrate on operating the vessel.

TOWING SAFELY

The MSA, MSR and VOZR state that:

- towing is only permitted in the period from one hour before sunrise to one hour after sunset
- a maximum of three persons can be towed at any one time. When towing multiple water skiers it is safer to have tow lines of the same length
- a person being towed is required to wear a type 1, 2 or 3 lifejacket at all times and types 2 or 3 are recommended
- once back in the vessel, the person who has been towed must wear the appropriate lifejacket for that vessel on the waterway being used. Speed and distance restrictions apply to the vessel as well as anything being towed
- the vessel must have carrying capacity for the master and observer. You should consider seating for any person/s being towed.



When you are the master towing a person or persons, do not turn around to watch or allow yourself to get distracted by other people in the vessel.

Details of speed restrictions and local operating and usage rules are generally displayed on signage on the shore or marked by buoys or beacons in the water and are contained in the notices published in the Victorian Government Gazette and the VOZR. They set out information such as the number of boats permitted on a waterway at any given time, direction of travel and days when towed sports can be undertaken.

Masters of vessels need to be aware that areas may be set aside where specific activities are prohibited (for example, no waterskiing, no bathing), or that areas may be set aside for exclusive use (for example, sailing vessels only).

Further information may be obtained from the relevant waterway manager or from TSV. To find out more information about waterway managers, visit transportsafety.vic.gov.au/msv/waterways

All vessels must travel at a safe speed at all times. A safe speed cannot be expressed as a maximum or minimum number of knots because it varies with circumstances and conditions. The operator must always assess the safety of the vessel's speed.

Towed water sports are exciting, however consideration needs to be given to the combination of relatively narrow waterways, conflicting usage, crowds during busy periods and the relatively high speeds involved. All of these factors create risks.

Things to take into consideration are:

- waterway courses and water levels constantly change, so be aware of submerged or floating objects
- if applicable, check waterway levels with the local waterway manager before you go out
- check your intended course to look for any hazards in the area every time you go out
- speed and distance restrictions apply to the vessel as well as anything being towed
- avoid towing in areas being used by others, such as swimmers or anglers
- seek out boating areas with plenty of room and not too much boating traffic
- handle wake with care by slowing the boat down when crossing wakes. Persons being towed at high speeds can be seriously injured by bouncing on the wakes of other vessels
- multiple occupants of inflatable devices have an increased risk of injury due to collisions between occupants
- physical fitness plays a crucial role in preventing or decreasing serious injury. Work on your fitness pre and post season to ensure you've given yourself the best possible chance to enjoy your activity
- slow down to reduce wake before commencing a turn to pick up a fallen skier
- on inland waters, vessels are required to travel in an anticlockwise direction in relation to the approximate centre of the waterway, except in a speed restriction zone or where local rules provide for travel in a clockwise direction
- inflatable items being towed tend to be pulled to the outside of turns as they have little grip on the water, resulting in high speeds and little directional control during turns
- all turns on the Murray River must be in an anti-clockwise (left-hand) direction. This helps you keep to the starboard side in the direction of travel at all times
- dropped skis, ski ropes, biscuits etc must not be left in the water where they can be a hazard to other traffic.

NO WASH ZONES

Vessel wake may impact other waterway users such as moored and anchored vessels, bathers, human powered vessels such as kayakers and onshore anglers.

Wake can cause moored or anchored vessels to be damaged and persons to fall overboard. Human powered vessels, such as kayaks and canoes, may be impacted by large waves, which could also lead to an overboard, capsizing or swamping incident. Swimmers may also be swamped by wake waves.

Masters of vessels need to be aware that 'No Wash' zones are where a vessel must proceed at a speed that creates minimal wash.

ACCESS LANES

An access lane is an area set aside for vessels engaged in towed water sports, such as waterskiing, to access the shore at unrestricted speed while towing.

Vessels may only operate in an access lane for the purpose of dropping off or picking up a water-skier or accessing a launching ramp located within the access lane.

Vessels must follow the correct direction of operation when entering or leaving the access lane. Keep as far right as possible or, if the lane specifies travelling in a clockwise direction, keep as far left as possible.

Vessels in an access lane must give way to vessels that are proceeding past the access lane or dropping off a water skier.









Further information can be obtained from the relevant waterway manager or the VOZR. Visit transportsafety.vic.gov.au/msv/waterways for more information.



HAND SIGNALS

Boat operators, observers and waterskiers should learn the following hand signals.

They are the most commonly used to communicate when participating in towed water sports.

HAND SIGNALS			
<p>1. Speed up Thumbs up</p>		<p>5. Cut motor Slashing hand across throat</p>	
<p>2. Slow down Thumbs down</p>		<p>6. OK after all Hands clasped over the head</p>	
<p>3. Turn Circling motion above head followed by pointing in the direction of the turn</p>		<p>7. Stop Hand raised with fingers outstretched</p>	
<p>4. Back to shore Pat top of head</p>		<p>8. All OK An 'O' made with the thumb and index finger</p>	

CHAPTER 3

EMERGENCY PROCEDURES

COPING WITH EMERGENCIES	112
Marine Radio Victoria	113
Emergency position indicating radio beacon (EPIRB) and personal locator beacon (PLB)	115
Flares	115
ABANDONING VESSEL	117
PERSON OVERBOARD	117
COLD WATER IMMERSION	118
Cold shock	118
Hypothermia	118
FIRE	120
Fighting the fire	120
Helping another vessel on fire	120
CARBON MONOXIDE POISONING	121
FIRST AID	122
REPORTING INCIDENTS AND ACCIDENTS	122



EMERGENCY PROCEDURES

ALL OCCUPANTS TO PUT ON LIFEJACKETS



RAISING THE ALARM - HOW TO GET HELP



BY PHONE:
Call 000



BY FLARES:
Activate when you see a potential rescuer or when you believe they will be seen



BY MARINE RADIO:
VHF - Ch 16,
VHF - Distress button
on DSC equipped and
registered radios

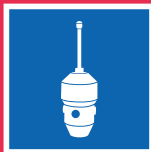

BY EPIRB/PLB:
Activate your distress beacon:
a PLB or registered EPIRB

STAY WITH YOUR BOAT



- A vessel is a lot easier to spot than a person
- Anchor your vessel to maintain position if it is safe to do so.



As of 1 February 2009 only digital 406MHz EPIRBs are detected by satellite. Analogue 121.5MHz EPIRBs are not detected. Switch to a digital 406MHz EPIRB and register it with the Australian Maritime Safety Authority.

COPING WITH EMERGENCIES

Most emergencies afloat can be avoided by good seamanship. However, they can happen to the most experienced operator on even the best maintained vessels so you need to be equipped to handle them. Not only do you need to carry safety equipment on board, you must know how to use it.

Reviewing and practising emergency procedures should be part of your boating habits.

TELEPHONE

Call 000 or Water Police on 1800 135 729. If you don't have a waterproof phone, it is recommended you store your phone in a waterproof container on your boat.



MARINE RADIO VICTORIA

Marine Radio Victoria (MRV) replaces Coast Radio Melbourne and provides the marine distress and emergency monitoring system for Victorian coastal waters.

MRV uses a new VHF coastal network completed in 2017. Radio calls are monitored and recorded 24/7 along the entire Victorian coastline out to 20 nautical miles off shore.

Distress channels/frequencies

This table provides a summary of the channel frequencies for each radio type.

RADIO TYPE	CHANNEL FREQUENCIES
VHF	16 (67 alternative)
27MHZ	88
HF	4125, 6215 and 8291 KHz

Distress call format

A distress message is used only when there is grave and imminent danger to a vessel. It has absolute priority over all other transmissions and may only be transmitted on the authority of the master or the person responsible for the safety of your vessel. The distress call 'MAYDAY' (spoken three times) should be used to indicate that vessel is in grave and imminent danger.

DISTRESS CALL

Distress signal (x3) MAYDAY, MAYDAY, MAYDAY

Words "this is" THIS IS

Station calling (x3) MAPLE MS742, MAPLE MS742, MAPLE MS742



DISTRESS MESSAGE

Distress signal MAYDAY

Name/call sign MAPLE MS742

Position 5 NAUTICAL MILES SOUTH OF FAWKNER BEACON

Nature of distress SWAMPED AND SINKING. ESTIMATE FURTHER 10 MINUTES AFLOAT

Other information SEVEN METRE HALF CAB WHITE HULL WITH BLUE AWNING

(If time permits) THREE PERSONS ON BOARD EPIRB ACTIVATED OVER

If no answer is received, repeat the distress call and message on the other distress frequencies or any other available frequency on which help might be obtained.

Urgency call

When a distress call is not fully justified, the urgency call 'PAN PAN' (spoken three times) should be used to indicate that a very urgent message follows concerning the safety of a vessel or person. The call details should be the same format as for a distress message except with the message beginning: 'PAN PAN, PAN PAN, PAN PAN'.

Safety signal

Safety signals are used when a station wants to pass important information such as navigational or weather warnings and are identified by the word 'SECURITE' (spoken three times as SAY-CURE-E-TAY).

Digital selective calling (DSC)

VHF radios that are DSC enabled transmit a range of vessel identification information at the press of a button. This includes location information if connected to a global positioning system. If linked, search and radio agencies are able to get a good fix on your location, improving your chances of being located.



A DSC enabled radio must be linked to a mobile maritime service identity (MMSI) number for full functionality. The MMSI number is issued by AMSA and applicants must hold a minimum of an Australian Waters Qualification. Refer to Marine radio operator certification in Chapter 1 - Trip Preparation for more information.

EMERGENCY POSITION INDICATING RADIO BEACON (EPIRB) AND PERSONAL LOCATOR BEACON (PLB)

Once an EPIRB or PLB has been activated, leave it on until instructed by rescue authorities to switch it off. Your beacon is the best reference point for rescuers whose aircraft, vessels and vehicles may not be able to remain with you throughout the emergency. If you must abandon your vessel, attach the beacon to yourself, not the vessel.

While EPIRBs are required by law to be carried when operating more than 2 nm from the coast, MSV recommends operators on other waters also carry an EPIRB or wear a PLB when operating alone.

FLARES

Be aware that different brands of flares may differ in their firing methods. Carefully follow the instructions for your flares, as a misfire or misuse can cause injury. Remember, it is an offence to misuse flares, or to activate a flare for 'practice'.

For more information on carriage, use and disposal of flares see Chapter 1 on Essentials for Safe Boating on page 19.

1. Check instructions



2. Remove cap









3. Pull yellow knob upward and outward

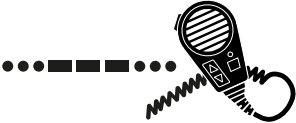

4. Hold out and leeward (down wind)

Internationally recognised distress signals

The following signals are some of those that are internationally recognized and indicate distress and need of assistance. Use of these signals except for the purpose indicated is prohibited.

DESCRIPTION	SIGNAL
1. Rockets or shells throwing red stars fired one at a time at short intervals.	
2. (a) signal made by any light or sound signalling method consisting of the group in the Morse code – SOS (b) a signal sent by radio consisting of the spoken word, MAYDAY	
3. A rocket parachute flare or a hand-held flare showing a red light.	
4. A smoke signal giving off orange-coloured smoke.	
5. Slowly and repeatedly raising and lowering arms outstretched to each side.	
6. (a). A rectangle of the internationally accepted colour orange material with a black letter v. (b). A rectangle of the internationally accepted colour orange material with a black square and circle.	
7. EPIRB	
8. Continuous sound of fog horn.	

ABANDONING VESSEL

If your vessel capsizes and you are unable to right the vessel, stay with it to improve your chances of being seen by the rescue vessel. A vessel is a lot easier to spot than a person or persons in the water. Do not remove your lifejacket and, if you are in the water, stay together in a HUDDLE or HELP position.

Do not try to swim ashore unless it is very close and a suitable landing place exists. Distances can be deceptive.

Try to get the EPIRB and distress signals out of the capsized vessel and raise the alarm. Make yourself as visible as you can to both ships and aircraft. Put on more clothes if you are able to. They will help to keep you warm and may delay the onset of hypothermia.

Abandon the vessel as a last resort and take the EPIRB and distress signals with you. Switch on the EPIRB and leave it on until emergency services tell you to turn it off.

PERSON OVERBOARD

When people fall overboard, the worst thing to do is jump in after them. The potential for drowning immediately doubles. If the person overboard is close to the vessel put the motor in neutral, raise the alarm and swing the propeller quickly away from them.

Throw a lifebuoy ring, horseshoe or lifejacket to them and keep them in sight at all times.

Ask someone on board to point continuously at the person in the water for the reference of others on board who may be preparing equipment or other head-down activities.

Check your bearings relative to any prominent landmarks. If operating with a GPS or chart plotter it may be possible to quickly create a waypoint where the event occurred. These will assist if a search is required.

Position the vessel to bring the person alongside then stop engines to avoid striking them with a spinning propeller.

Help the person into the vessel, preferably over the stern, as a small vessel might capsize or take on water if you try taking them in over the side. On yachts with overhanging sterns, they should be pulled in at the lowest point of the freeboard.

It is recommended that your vessel is fitted with a ladder or that you carry a portable ladder to help with reboarding a person in the water.

A person recovered from the water may be hurt, cold or exhausted. If they cannot help themselves, it is difficult to get them back into the vessel. Practice your 'man overboard' drill whenever possible and in all conditions.

COLD WATER IMMERSION

COLD SHOCK

Victoria's coastal waters range from about 9.5°C in midwinter to about 22°C in midsummer. Cold shock can kill long before hypothermia. When a person falls into water less than 15°C the first reflex is to gasp and then to hyperventilate making it extremely difficult to hold your breath. The heartbeat may become very fast and irregular during this time. There is a high danger of drowning if the head is not kept above water. It may take several minutes to regain control of breathing and become able to climb back aboard if this remains possible.

You lose strength and coordination quickly in cold water, typically in 10 to 15 minutes. It is important to inflate lifejackets and rafts, and set off EPIRBs quickly for the best chance of survival and rescue. Prepare flares and signals next, so they are easy to access and deploy when help arrives

Activity such as swimming will increase heat loss. Hypothermia commences when the body core temperature reduces, typically within an hour of immersion.

If you fall into cold Victorian waters you will generally have:

- 1 minute to get your breathing under control and keep your head out of the water
- 10 to 20 minutes of useful movement in which to get out of the water to prepare for rescue
- 1 to 3 hours before you become unconscious due to hypothermia.

HYPOTHERMIA

The term 'hypothermia' means lowering deep-body or core temperature. 'Immersion hypothermia' is an acute type of hypothermia produced when a person is immersed in cold water such as experienced in Victoria in winter.

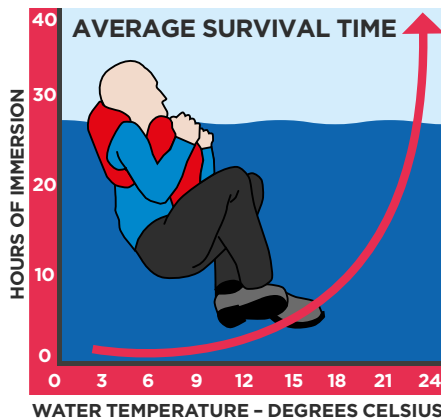

The time is very short when you include the time lost before a search and rescue operation is under way.

The heat escape lessening posture (HELP) pictured combats hypothermia and can be a lifesaver for people in cold water.

The HUDDLE position can also be used if there is more than one person in the water. To reduce body heat loss, make sure you stay close (huddle together) and remain still.



WARNING: the consumption of alcohol, attempting to swim or movement in the water will cause the body to use up heat rapidly, which will hasten the onset of hypothermia.

Key points for treatment of hypothermia

1. Remove the person from the cold-inducing environment.
2. Protect the person from cold wind.
3. Remove wet clothing if practical.
4. Warm victim with dry blankets, towels or skin-to-skin contact.
5. Warm the area of high heat loss, that is, head and neck, sides of chest, armpits, and groin. Do not warm, rub or massage limbs. This stimulates the skin and takes warm blood away from vital organs.
6. Observe the person for deterioration in condition.
7. Manage an unconscious person by placing them in the lateral position, making sure their airway is clear. Continue warming procedures.
8. Do not give the person alcohol.
9. Do not allow the person to walk around.
10. Seek medical assistance.



FIRE

FIGHTING THE FIRE

- Raise the alarm (to others onboard and to rescue organisations).
- Manoeuvre the vessel to operate with the least wind effect (generally downwind).
- If within an enclosed or confined space, close all the hatches, vents and ports to reduce oxygen.
- If a burning object can be safely moved, get it over the side quickly.
- Shut off fuel lines and gas lines immediately as flexible fuel lines may collapse and add to the fire.
- Try to extinguish the fire with fire fighting appliances and remember to direct the extinguisher into the heart of the fire not the flames.
- Maintain a watch on the area once the fire has been extinguished and monitor for any re-ignition.
- Do not motor up to another vessel if you need to abandon your vessel.
- If you need to abandon the vessel leave on the windward side (upwind) to stay clear if the vessel drifts and any fuel spreads in the water.



In an emergency, make sure you are wearing your lifejacket.

HELPING ANOTHER VESSEL ON FIRE

As a master your responsibility lies first with your own vessel and all persons on it. Provide what aid you can reasonably give, according to your knowledge and experience, and your vessel's capabilities.

- Fires on other craft are indicated by large black smoke palls.
- Be extremely cautious as you approach and keep to the windward side of the vessel on fire.
- Remember most fires on small vessels originate from fuel, heating appliances, stoves, leaking gas or cooking fats and oils. Fuel and gas fires spread very quickly. Even a minor spill can create an almost explosive spread of flames.

CARBON MONOXIDE POISONING

Carbon monoxide is a common part of exhaust gases from engines, generators and stoves using any kind of fuel. It is colourless, odourless and very toxic. CO diffuses with air and quickly spreads to restricted spaces such as cabins and engine bays, and on low surfaces such as the water beside exhaust ports and under duck boards at the stern of powerboats.

TO AVOID CARBON MONOXIDE POISONING:

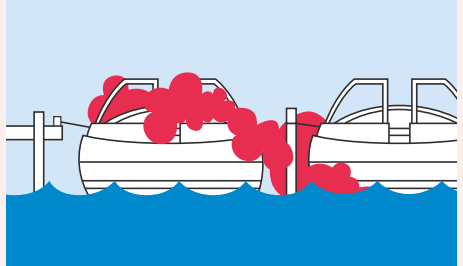
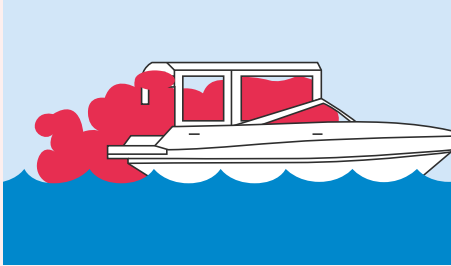

- ensure inboard engines exhaust outside the vessel
- make sure canvas enclosures are adequately ventilated
- ensure stoves and fuel heaters are exhausted outside the cabin
- never use a gas stove or oven for heating
- keep cabins and engine bays well ventilated
- make sure the engine bay vents are outside the cabin
- be aware of another vessel's exhaust. Carbon monoxide from the boat docked next to you can be just as deadly
- install carbon monoxide alarms in cabins and keep them serviced regularly
- be wary when external exhaust gases are blown by the wind into the cabin or into a sheltered part of the deck for any length of time
- always have your equipment installed and serviced by a competent person

SYMPTOMS

- Dull headache
- Weakness
- Dizziness
- Nausea or vomiting
- Shortness of breath
- Confusion
- Blurred vision
- Loss of consciousness

Carbon monoxide poisoning can be especially dangerous for people who are sleeping or intoxicated.

TREATMENT

- get the victim into fresh air, being careful not to be exposed yourself
- seek immediate medical attention.

FIRST AID

Every vessel should have a suitable first-aid kit on board. A simple kit can be purchased from a chemist shop and supplemented with sunburn cream, seasickness tablets and a pair of side cutting pliers for removing fish hooks. Make sure it contains adequate wound and burn dressings.

The kit should be kept in a sturdy, watertight plastic container, clearly marked and secured in a position where anyone on board can reach it if necessary. A booklet giving basic first-aid methods is an essential addition to the kit. MSV recommends operators obtain first aid training.

More information on emergencies at transportsafety.vic.gov.au/msv/emergency

REPORTING INCIDENTS AND ACCIDENTS

Always dial **000** in an emergency. If an incident has occurred but you are not in immediate danger, report it to Victoria Police on **1800 135 729**.

Where death, injury or property damage occurs, report the incident details as soon as possible to the police officers present or to the police station nearest to where the accident took place.

Vessel operators involved in an accident must give assistance to other persons involved, without endangering their own vessel, crew or passengers.

They must give their name, address, identification and registration details to (when applicable) any person injured or his or her representative, to the owner of any property damaged and to the police present at the scene.

CHAPTER 4

LICENSING AND REGISTRATION

RECREATIONAL MARINE LICENSING	125
TYPES OF MARINE LICENCES	126
General marine licence	126
Restricted marine licence	126
Personal watercraft (PWC) endorsed marine licence	126
OPERATING UNDER SUPERVISION	127
HIRE AND DRIVE REQUIREMENTS	127
OBTAINING A MARINE LICENCE	128
What is involved in the test?	129
Accessibility options	129
MARINE LICENCE FEES	129
INTERSTATE MARINE LICENCE HOLDERS	129
VICTORIANS TRAVELLING INTERSTATE	130
PEOPLE VISITING VICTORIA	130
COMMERCIAL MARINE QUALIFICATIONS HOLDERS	130
EVIDENCE OF IDENTITY	130
APPLICANTS WITH POOR VISION	131
APPLICANTS WITH A DISABILITY OR MEDICAL CONDITION	131
VESSEL REGISTRATION REQUIREMENTS	131
REGISTRATION LABELS AND IDENTIFICATION MARKS	132
HULL IDENTIFICATION NUMBER	132
Attaching a HIN to a vessel	132



RECREATIONAL MARINE LICENSING

All masters operating a powered recreational vessel on Victorian waters require a marine licence. The *Marine Safety Act 2010 (Vic)* (MSA) makes it an offence to be a master of:

- a registered recreational vessel unless the person holds a marine licence
- a personal watercraft (PWC) unless the person holds a marine licence endorsed for this type of recreational vessel.

Valid interstate marine licences are recognised in Victoria for up to three months.

Please note:

- any person operating a powered vessel registered in Victoria must carry their marine licence at all times
- licences are only issued for a period of five years.



TYPES OF MARINE LICENCES

GENERAL MARINE LICENCE

A general marine licence is required by any person 16 years of age and over who is operating a powered recreational vessel.

RESTRICTED MARINE LICENCE

A restricted marine licence is required by any person over the age of 12, but under the age of 16, who is operating a powered recreational vessel.

Restricted marine licence conditions

Holders of a restricted marine licence may act as master of a recreational vessel only if:

- operating during daylight hours between sunrise and sunset
- operating at speeds of less than 10 knots and
- not operating a vessel that is towing a person, another vessel or object.

Once a licence holder turns 16 years old, the restricted marine licence automatically becomes a general marine licence.

PERSONAL WATERCRAFT (PWC) ENDORSED MARINE LICENCE

Masters of Personal Watercraft (PWCs) must obtain an endorsement on their general marine licence in order to operate this type of vessel.

A PWC endorsement may not be issued as a standalone licence. If an endorsement is required, a marine licence must first be obtained.



Following changes to the law in 2017, new applicants under the age of 16 are not eligible for a PWC endorsement on their restricted licence.

OPERATING UNDER SUPERVISION

Under the MSA an unlicensed person may operate a vessel under the direct supervision of a person who is:

- a. over the age of 18 years
- b. licensed and endorsed appropriately for the vessel being operated (for example, if a PWC is being operated, the licence must be endorsed for PWC operation)
- c. on board the vessel in a position where they are able to take immediate control of the vessel.



A licensed operator must be able to immediately take control of the vessel when needed.

HIRE AND DRIVE REQUIREMENTS

A hire and drive vessel means a vessel (other than a recreational vessel) that is intended to be let for hire. It includes vessels hired on a trailer and operated away from the place of hire, including those only capable of a speed less than 10 knots. A PWC endorsement is required to operate a hired PWC.

The MSA requires all masters to hold a marine licence (and any relevant endorsement) to operate a hire and drive vessel capable of a speed greater than 10 knots (18km/h). The hire boat owner is to brief clients on the operating requirements of the vessel being hired.

All operators, masters and passengers must comply with lifejacket wearing requirements outlined on page 45.



OBTAINING A MARINE LICENCE

There are two ways to obtain a recreational boat licence in Victoria:

1. Accredited Training Providers

You can undertake a boating safety course with an Accredited Training Provider (ATP). On successful completion of the course, you will sit the test provided by the ATP. You must provide evidence of identity consistent with VicRoads requirements to the test supervisor (refer to the evidence of identity section in this chapter for more information) prior to the test.

When you pass you will receive a Transport Safety Victoria (TSV) endorsed certificate which you must take to VicRoads within 12 months of completing the course (as marked on the certificate) to receive your marine licence. You must present the same proof of identity documents that you used to sit the test.

Note: Applicants should check the cancellation and refund policies of ATPs before enrolling in any course offered.

2. Computer-based testing at VicRoads

Your other option is to sit the computer-based test at a VicRoads office. Test fees apply when booking at a VicRoads customer service centre. Please have your payment ready at the time of making the appointment.

When booking a test, an applicant will also be asked personal details such as name, date of birth and address. Depending on availability, an applicant can nominate when and where they would like to be tested. Each applicant will be given an appointment number, which is to be presented to the VicRoads test supervisor who conducts the test.

Note: Applicants wishing to cancel an appointment must give the testing VicRoads office at least 24 hours notice. Otherwise fees will not be refunded unless a medical certificate or other supporting evidence is produced.



Practical boating safety training courses offered by ATPs are highly recommended for any person considering obtaining a marine licence or endorsement. For more information about licensing and a list of TSV ATPs, visit transportsafety.vic.gov.au/msv/licence.

WHAT IS INVOLVED IN THE TEST?

Applicants for a marine licence demonstrate the level of competency required by passing an appropriate test of knowledge. Whether you sit the test with the accredited training provider or at a VicRoads customer service centre, the test will be multiple choice to assess your knowledge of safe vessel operation. Test questions are based on all chapters of this Safety Handbook.

A separate PWC endorsement test is required in addition to the marine licence. The course and assessment can be completed up to 12 months before the endorsement is obtained and may also be undertaken at an ATP or any VicRoads customer service centre.

To obtain a passing grade for the marine licence the applicant must correctly answer 26 out of 30 questions.

To obtain a passing grade for the PWC endorsement the applicant must correctly answer 13 out of an additional 15 questions.

You can try our marine licence and PWC endorsement practice tests at transportsafety.vic.gov.au/msv/test. The practice tests include sample questions from the actual test but not necessarily those you will be asked.

ACCESSIBILITY OPTIONS

Your ATP will make arrangements if you need an interpreter while you sit the marine licence and/or PWC endorsement course. Please speak to the ATP.

If you take your marine licence and/or PWC endorsement test at VicRoads, please contact them on **13 11 71** if you need an interpreter in any language. You may also ask for assistance if you are hearing impaired.

MARINE LICENCE FEES

Fees apply to marine licences and PWC endorsements. For information on current fee amounts, visit vicroads.vic.gov.au/licences.

INTERSTATE MARINE LICENCE HOLDERS

A person who holds an interstate marine licence, restricted marine licence, or PWC endorsed marine licence may operate the equivalent vessel in Victoria for a period of three months. If the visitor's stay extends beyond three months or the visitor does not have an equivalent interstate marine licence for the vessel they wish to operate, a Victorian marine licence must be obtained.

Note: Interstate visitors are required to observe Victorian regulations including speed restrictions and the wearing of lifejackets at certain times. An exemption applies for visiting vessels for the carriage of safety equipment – see page 35 for further detail.

If you are an interstate marine licence holder but have resided in Victoria for more than three months, you must convert your interstate marine licence to a Victorian marine licence. If you have evidence of your equivalent interstate marine licence, you will be exempt from sitting the test delivered by VicRoads or an ATP. To convert your marine licence, please bring your existing interstate marine licence and appropriate evidence of identity to a VicRoads customer service centre (fees apply).

VICTORIANS TRAVELLING INTERSTATE

MSV advises all Victorians who travel interstate to familiarise themselves and comply with local waterway rules. See pages 57 for details on boating in NSW.

PEOPLE VISITING VICTORIA

Holders of interstate marine licences who travel to Victoria must familiarise themselves with the marine safety laws applicable in Victoria, local waterway rules and the contents of this Safety Handbook.

COMMERCIAL MARINE QUALIFICATIONS HOLDERS

Under the *Marine Safety Regulations 2012* (Vic) (MSR) if you hold a commercial certificate of competency that is recognised under the *Marine Safety (Domestic Commercial Vessel) National Law Act 2012* (Cth) you may be:

- exempt from the requirement to hold a recreational marine licence
- exempt from sitting the test run by VicRoads or an ATP.

To apply for a recreational marine licence take your valid certificate of competency and appropriate evidence of identity to a VicRoads customer service centre (fees apply).

A Certificate of Competency is not able to be endorsed to operate a PWC. If you want to operate a PWC, you will need to apply for a marine license and complete the PWC endorsement test with an ATP or at a VicRoads Office.

For more information please contact MSV on **1800 223 022**.

EVIDENCE OF IDENTITY

Before a marine licence, restricted marine licence, or PWC endorsement can be issued, an applicant must provide one primary and one secondary document as evidence of identity. Additional documentation may be required if the documents are not in English or if documents show different names. Original documents should be presented.

Visit any VicRoads customer service centre or vicroads.vic.gov.au for details of acceptable evidence of identity.

APPLICANTS WITH POOR VISION

Applicants with poor vision must provide an eyesight certificate from an optometrist, a registered medical practitioner, occupational therapist or ophthalmologist with their licence application.

APPLICANTS WITH A DISABILITY OR MEDICAL CONDITION

Applicants with a disability or medical condition, that may affect their ability to operate a vessel, should contact VicRoads as further information or testing may be required.

Note: A licence holder must inform VicRoads if they develop any medical condition or any previously disclosed medical condition has deteriorated which might affect the safe operation of a vessel.

If you would like further information on any aspect of the marine licensing process, please telephone VicRoads on **13 11 71**. If you have queries about whether your certificate of competency grants you an exemption, contact MSV on **1800 223 022**.

VESSEL REGISTRATION REQUIREMENTS

The MSA requires the owner of a recreational powered vessel (one equipped with an engine that is capable of being used for propulsion) to register the vessel. It is an offence to cause or allow a vessel to be operated on Victorian waters unless the vessel is:

- registered in accordance with the marine safety laws, or
- exempt from registration.

You should only apply for registration of a vessel if you own or manage the vessel and are over the age of 14. To apply, you must provide evidence of identity and address, specific details of the vessel being registered and pay the fee for vessel registration, that is based on vessel length.

A recreational tender is exempt from registration and is a vessel that:

- does not exceed 4.8 m in length; and
- is used as a means of transport within 300 m of its mother vessel to the shore or another vessel.

For more information about vessel registration, visit vicroads.vic.gov.au/registration

REGISTRATION LABELS AND IDENTIFICATION MARKS

Under the MSR the owner of a registered recreational vessel must ensure that the registration label for that vessel, issued by VicRoads on behalf of TSV, is fixed and remains fixed in an obvious position on the outside or upper part of the vessel.

The owner of a registered recreational vessel, that is not a personal watercraft, must ensure that the assigned identification mark is painted or displayed:

- on each side of the hull of the vessel
- forward of the beam
- so that the highest part of each digit commences at a point no more than 75 millimetres below the gunwale
- in characters that are:
 - no less than 150 millimetres high
 - in proportionate breadth
 - coloured in contrast to the surface on which they are displayed.

A recreational tender is required to display the name of its mother ship or the registration number of that vessel and the letter 'T'.

The owner of a registered personal watercraft must ensure that the assigned identification mark is painted or displayed:

- on each side of the hull of the vessel
- forward of the beam
- so that the highest part of each digit commences at a point no more than 25 millimetres below the gunwale
- in characters that are:
 - no less than 100 mm high -
 - in proportionate breadth
 - coloured in contrast to the surface on which they are displayed.

HULL IDENTIFICATION NUMBER

A Hull Identification Number (HIN) is permanently affixed to a boat's hull. It includes a unique national serial number along with information regarding the country of origin, and either manufacturer, model and year of production details for new boats, or an authorised agent code and the year it was affixed.

A HIN is not required for vessels to be registered in Victoria. If however your vessel has a HIN affixed you must provide the number during the registration process.

ATTACHING A HIN TO A VESSEL

To obtain advice on the use, or acquisition, of a HIN visit the Boating Industry Association at bia.org.au.

CHAPTER 5

PERSONAL WATERCRAFT (PWC)

PERSONAL WATERCRAFT	135
PWC OPERATOR CONDUCT	135
SPEED AND DISTANCE RULES	136
Safe speed	136
Keep your distance	137
KNOW THE COLLISION REGULATIONS	138
HOON LAWS	138
NOISE	138
SAFETY EQUIPMENT	139
TOWED WATER SPORTS	139
CARRYING CAPACITY	139
PENALTIES	139
LICENSING AND REGISTRATION	140
RIDE RIGHT	141

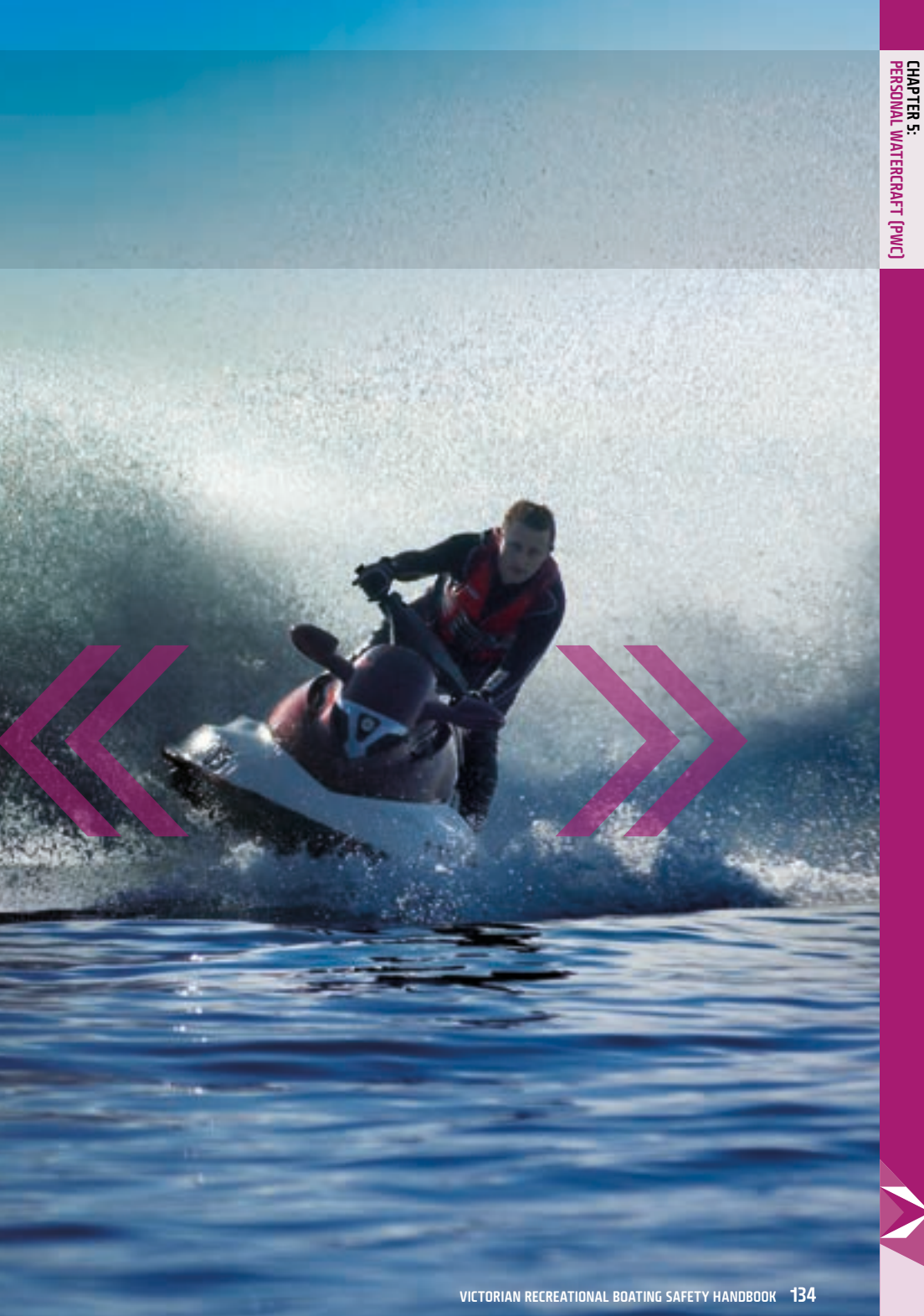

PERSONAL WATERCRAFT

A personal watercraft (PWC) is defined under the *Marine Safety Act 2010* (Vic) (MSA) as any recreational vessel that is of a kind that is required to be registered and that:

- a. has an engine that is used for propulsion
- b. has a fully enclosed hull
- c. does not retain water on it if it capsizes, and
- d. is designed to be operated by a person standing, sitting astride or kneeling on the vessel but not seated within the vessel.

PWC OPERATOR CONDUCT

Regardless of the type of PWC, it is important for operators to remember that PWCs are a type of vessel and are required to be operated within the rules pertaining to 'powerboats'. PWCs are generally much more powerful and manoeuvrable than traditional powerboats and, in the wrong hands, can present a danger to the operator and to other people using our waterways.

A recent Monash University study commissioned by TSV examined data from 2005 to 2015 and found that:

- PWCs are the vessel most commonly involved in marine accidents and account for more than 30% of accidents
- the types of injuries suffered include leg fractures and other injuries to knees, legs and feet
- injuries incurred on PWC are a common cause of people needing treatment at hospital
- these injuries are on the rise every year, with more people being admitted to hospital as a consequence.

Many collisions between vessels result from a lack of understanding of the rules of safe navigation and/or carelessness.

Remember, PWC operators are required to:

- maintain a proper lookout and travel at a safe speed at all times
- observe the rules.

SPEED AND DISTANCE RULES

PWC operators should:

- check for local rules which may apply specifically to PWCs, such as personal watercraft prohibited zones
- observe the rules
- know their limitations as well as the limitations of the vessel in varying conditions
- be aware of potential hazards (allowing for the action of others, both reasonable and unreasonable)
- follow vessel manufacturer's instructions and maintenance schedule
- consider joining a PWC riders club or similar organisation to improve skills, knowledge and experience.

When death, injury or property damage occurs, report the incident details as soon as possible to the police officers present or to the police station nearest to where the accident took place.

Remember:

- in surf areas, swimmers may be hidden from view by waves and swell. Keep well away from areas where swimmers are likely to be present or slow right down
- do not cut blind corners – slow down
- if vision is affected by the sun or spray – slow down or stop
- keep well clear of anchored or moored vessels
- in channels and narrow stretches of water, you must operate on the right hand or starboard side
- on circular bodies of water, travel in an anticlockwise pattern unless local waterway rules specify otherwise
- stay out of PWC exclusion zones.

SAFE SPEED

All vessels are required to travel at a safe speed at all times. Manufacturers are progressively introducing improvements that help the operator control the PWC and potentially avoid a collision. While these improvements are beneficial to new operators; nothing replaces the need to learn the proper skills and have the knowledge required to confidently and safely operate the PWC.

The operator of a PWC must constantly monitor the speed of the vessel to ensure that a safe speed is being maintained. Follow speed signs and buoys marking waterway zones.

Remember, stunts and manoeuvres must be done well away from other people, other vessels and the shore. If you cannot maintain the minimum distances off, you must slow down to 5 knots.



Without power, a PWC has little or no steering.

KEEP YOUR DISTANCE

The main complaint received by marine authorities relates to the operation of PWCs close to other water users and/or the water's edge.

These are minimum safety distances that must be applied on all waterways unless a specific local rule provides otherwise.

In Port Phillip Bay the 5 knot zone extends to 500 m of the waters edge from Martha Point to Point Nepean National Park.

Like any other boaters, PWC operators should make sure that they know the rules applicable to any waterway they intend to use. See the Vessel Operating and Zoning Rules (VOZR) for particulars and the general rules as outlined in this Safety Handbook.

When operating near beaches and swimmers, care must be taken to adhere to the speed and distance rules and be aware of people in the water.

On ALL Victorian waters a 5 knot speed limit applies to boat operators and PWC operators within a distance of:

50 m of a person, vessel, fixed or floating structure and the shore on inland waters

50 m of a person, vessel, wharf, jetty, slipway, diving platform or boat ramp on coastal and enclosed waters

100 m of a dive flag



200 m of the shore on enclosed and coastal waters

or as per the scheduled waterway rules



KNOW THE COLLISION REGULATIONS

The International Regulations for Preventing Collisions at Sea, which are adopted in Victoria by marine safety legislation, apply to operators of all vessels including PWC riders. It is the responsibility of anyone in charge of a PWC to be able to correctly apply these rules in all circumstances.

For more information on the Collision Regulations, refer to the 'Know the Collision Regulations' section in Chapter 2.



One of the most important rules is the requirement to maintain a proper look out at all times.

HOON LAWS

PWC operators are subject to hoon legislation. The master of a PWC must not operate at a speed or in a manner which is dangerous to the public, birds and marine animals.

A member of Victoria Police may exercise the power to seize, impound or immobilise a vessel. In addition, Victoria Police and MSV have the power to embargo and prohibit the use and operation of a vessel.

NOISE

One of the most common complaints received about PWCs is noise. PWC operators tend to congregate near residential or popular recreation areas and drive around repeatedly in the same area. This noise can be irritating to people using the foreshore and to residents often some distance from the water.

Individually, most PWCs are not excessively noisy when compared with other vessels. However, if continually operated close to the shore, in groups, 'porpoising' or performing manoeuvres, noise levels increase.

Don't operate a PWC in the early morning, or when winds are blowing onshore, if you are in populated areas – including camp sites.

Respect the peace of other people and wildlife and remember, the fewer complaints, the greater chance to enjoy the sport.

SAFETY EQUIPMENT

The operator and passengers, including anyone being towed, must wear an approved lifejacket Type 1, 2 or 3 at all times.

PWCs must also carry a working, waterproof and buoyant torch at all times. A torch can be used to signal the shore or other vessels if you encounter difficulties.

A PWC must show the navigation lights for a powerboat if operating at night. Note that a mast may be required for the all-round white light to ensure it is not obscured by the occupant(s).

A registered EPIRB is to be carried on all vessels, including PWCs, if operating more than 2 nm from the coast. Consider carrying an EPIRB on all waters or wearing a PLB in case you are separated from your PWC.

TOWED WATER SPORTS

PWCs are often used in towed water sports. Remember that when engaged in towed water sports on a PWC, the rules for towed water sports must be followed, including the need to carry an appropriate observer.

The PWC must have seating for the master and observer. You should consider having adequate seating for any person(s) being towed.

CARRYING CAPACITY

To determine the carrying capacity of your PWC, refer to the manufacturer's specifications.

PENALTIES

Boating is meant to be enjoyable and no one wants to finish up in trouble when they are out having fun.

To operate a PWC on any Victorian waters, all PWC operators must hold a Marine License with PWC endorsement.

Penalties exist for those operators who do not want to play by the rules. On-the-spot infringements may be issued by Victoria Police, TSV transport safety officers and other external officers appointed by the Safety Director.

LICENSING AND REGISTRATION

Approved boating safety training courses are highly recommended for any person considering obtaining a marine licence. For more information about licensing and a list of training providers, visit transportsafety.vic.gov.au/msv/licence and refer to Chapter 4 of this handbook.

Following a change to the law in 2017 persons under 16 are not eligible for a PWC endorsement on their restricted marine licence. They may still learn to operate a PWC provided they are directly supervised by a person over 18 who has a PWC endorsement and is on board the PWC in a position to take immediate control of the vessel.

The owner of a registered recreational vessel, that is a personal watercraft, must ensure that the identification mark that is assigned by the Safety Director for that vessel is painted or displayed in appropriate characters:

- a. on each side of the hull of the vessel
- b. forward of the beam, and
- c. so that the highest part of each digit commences at a point no more than 25 mm below the gunwale.

Appropriate characters means characters that are:

- a. no less than 100 mm high
- b. in proportionate breadth, and
- c. coloured in contrast to the surface on which they are displayed.

A person must not act as the master of a registered vessel on State waters unless an identification mark is painted or displayed on the vessel in accordance with the above.

These identification marks must take preference over decals and striping provided to decorate or customise the PWC.

Be a courteous rider!

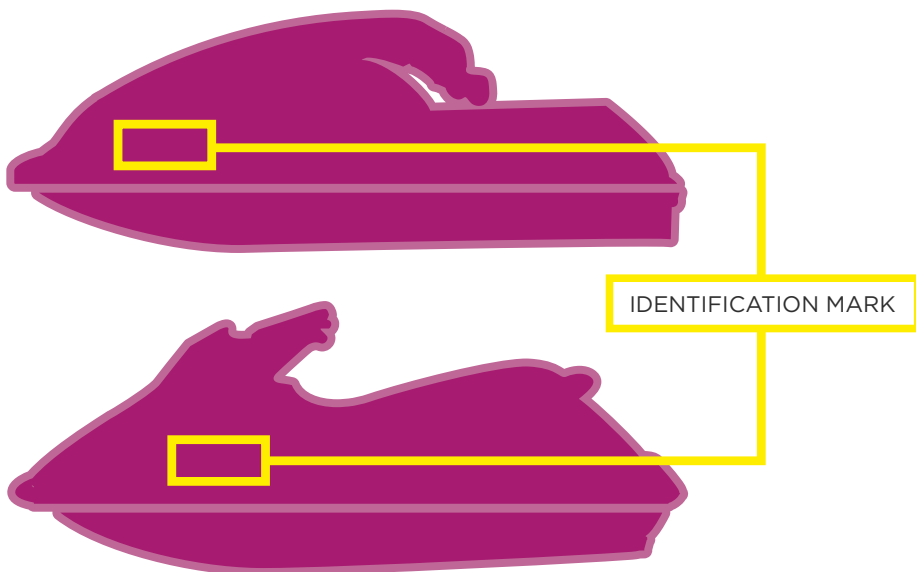

RIDE RIGHT

YOU MUST FOLLOW THESE RULES:



Carry your **marine licence** with PWC endorsement



Wear a **lifejacket** and attach engine **kill switch**



Maintain a **proper lookout** at all times and travel at a safe speed



Carry a **waterproof buoyant torch**



Carry an **EPIRB** if you're going more than 2 nm off shore



Respect the rules, others, wildlife, environment



We also recommend:
Carrying a **phone** and **PLB** so you can call for help, wearing **protective clothing** and **letting someone know** before you go.

RIDE RIGHT



MARITIME AUTHORITIES AND GOVERNMENT AGENCIES

STATE MARITIME AUTHORITIES

ACT/NSW – Roads and Maritime Services
rms.nsw.gov.au

NT – Department of Transport
transport.nt.gov.au

QLD – Maritime Safety Queensland
msq.qld.gov.au

SA – Department of Planning, Transport and Infrastructure
dpti.sa.gov.au

TAS – Marine and Safety Tasmania
mast.tas.gov.au

VIC – Maritime Safety Victoria
transportsafety.vic.gov.au/msv

WA – Department of Transport
transport.wa.gov.au

PORT AUTHORITIES

Gippsland Ports
gippslandports.vic.gov.au

Port of Hastings Development Authority
portofhastings.com

Victorian Regional Channels Authority
regionalchannels.vic.gov.au

Victorian Ports Corporation
vicports.vic.gov.au

Port of Melbourne
portofmelbourne.com

GOVERNMENT LINKS

Australian Communications and Media Authority
acma.gov.au

Bureau of Meteorology
bom.gov.au

Environmental Protection Authority
epa.vic.gov.au

Parks Victoria
parkweb.vic.gov.au

Play it safe by the water
watersafety.vic.gov.au

VicRoads
131171
vicroads.vic.gov.au

Victoria Police
police.vic.gov.au

NATIONAL MARITIME AUTHORITIES

Australian Maritime Safety Authority
amsa.gov.au

Copyright

© Director, Transport Safety, Australia, 2018
ISBN 978-1-76090-017-5

Copyright in this publication resides with the Director, Transport Safety and the State of Victoria. No part of this publication may be reproduced by any process except in accordance with the provisions of the *Copyright Act 1968* (Cth).

This handbook is intended as a guide only, and is not a substitute for the relevant legislation, legal or professional advice. Laws relating to the operation of recreational vessels change from time to time. Tests may change accordingly.

For a complete knowledge of marine safety legislation and waterway rules, you should consult the *Marine Safety Act 2010* (Vic) and associated regulations and notices published in the Victoria Government Gazette. Copies of Victorian legislation and parliamentary documents are provided online at www.legislation.vic.gov.au.

In preparing this edition of the *Victorian Recreational Boating Safety Handbook*, Transport Safety Victoria gratefully acknowledges that information, images, layout and formatting material have been drawn from the following sources:

- the staff of Transport Safety Victoria and its predecessor organisations
- Victorian and Commonwealth marine safety legislation including sections relating to international conventions such as the International Regulations for Preventing Collisions at Sea 1972 (COLREGS)
- the International Association of Marine Aids to Navigation and Lighthouse Authorities (IALA)
- the South Australian Department of Transport, Energy and Infrastructure
- the Australian and New Zealand Safe Boating Education Group (ANZSBEG)
- VicRoads.

CONTACT US

Maritime Safety Victoria
PO Box 2392 Melbourne Victoria 3001
T 1800 223 022
E info@transportsafety.vic.gov.au
W transportsafety.vic.gov.au/msv



A branch
of Transport
Safety
Victoria

